

# Industrial enhanced-safety radio remote controls

# UD Series

EN



CE

## *Installation and user technical manual*

*(Translated from French original version 319472M-FR)*

# Table of contents

<b>1 - General safety rules and precautions .....</b>	<b>p. 6</b>
<b>2 - Description and operating principle.....</b>	<b>p. 7</b>
<b>3 - Unpacking the elements .....</b>	<b>p. 8</b>
<b>4 - Description of elements.....</b>	<b>p. 10</b>
4.1 Transmitter UDE.....	p. 10
4.1.1 Labeling the transmitter function buttons .....	p. 11
4.2 Chargers and batteries.....	p. 12
4.2.1 Battery storage precaution and general information .....	p. 12
4.2.2 Precaution when inserting battery pack in transmitter unit.....	p. 12
4.2.3 Indication of remaining battery level.....	p. 13
4.3 Electronic key.....	p. 14
4.4 Receiver URR .....	p. 16
4.5 Receiver UCR .....	p. 17
4.6 Receiver UDR .....	p. 18
<b>5 - Delivery configuration .....</b>	<b>p. 20</b>
<b>6 - Installation .....</b>	<b>p. 21</b>
6.1 Installation recommendations .....	p. 21
6.2 Dimension and implementation of elements .....	p. 21
6.2.1 Receiver URR .....	p. 21
6.2.2 Receiver UCR .....	p. 22
6.2.3 Receiver UDR .....	p. 22
6.2.4 Infrared module UDF.....	p. 23
6.2.5 Wall Bracket UDC1 for transmitter and battery .....	p. 23
6.2.6 Transmitter UDE.....	p. 24
6.2.7 Charger, voltage adapter and connector.....	p. 24
6.3 Receiver position.....	p. 25
6.4 UDF infrared module position (option) .....	p. 26
6.5 Marking the Controlled Equipment.....	p. 26
6.6 Auxiliary control.....	p. 26
6.7 Wiring the radio receiver .....	p. 27
6.7.1 Instructions for electrical connection of the receiver .....	p. 27
6.7.2 Conductor wire sections to be observed .....	p. 28
6.7.3 Opening the connection terminal strips on receivers URR and UCR.....	p. 28
6.7.4 Opening the connection terminal strips on receiver UDR .....	p. 28
6.7.5 Wiring the power supply.....	p. 29
6.7.6 Use of safety relays RS1 and RS2.....	p. 30
6.7.7 Interference suppression of the installation and protection of relay outputs .....	p. 30
6.7.8 Protection of the power supply.....	p. 30
6.8 Wiring diagrams and assignment of buttons/relays for standard assemblies .....	p. 31
6.8.1 Standard unit using receiver URR.....	p. 31
6.8.2 Standard units using receiver UCR.....	p. 32
6.8.3 Standard units using receiver UDR.....	p. 35
6.9 Choice of operating radio frequency .....	p. 39
6.9.1 Table of possible radio channels following the receiver used .....	p. 39
6.9.2 Radio frequency tables .....	p. 40
<b>7 - Configuration and Parameterization .....</b>	<b>p. 41</b>
7.1 Procedure: «Locking-unlocking» the electronic key.....	p. 42
7.2 Procedure: programming the radio frequency.....	p. 43
7.3 Procedure: time delay for the «Standby mode» function .....	p. 44
7.4 Procedure: Recopying the electronic key identity code .....	p. 45
7.5 Receiver configuration .....	p. 46
<b>8 - Commissioning and use.....</b>	<b>p. 47</b>
8.1 Precautions to be observed before commissioning .....	p. 47
8.2 Starting the radio control .....	p. 48

8.3	Operating chronogram .....	p. 49
8.4	Transmitter UDE indicator lights functions .....	p. 50
8.5	Receiver URR, UCR and UDR indicator lights functions .....	p. 52
8.6	Infrared module UDF indicator light .....	p. 54
<b>9</b>	<b>- Functions .....</b>	<b>p. 55</b>
9.1	«Standby mode» function .....	p. 55
<b>10</b>	<b>- Options .....</b>	<b>p. 56</b>
10.1	«start-up by IR validation» option .....	p. 56
10.2	«Transmitter/Receiver association on start-up» option .....	p. 57
<b>11</b>	<b>- «Plug-in antenna» kit OWR02 .....</b>	<b>p. 58</b>
11.1	Description of the kit OWR02 .....	p. 58
11.2	Installation on URR or UCR receiver .....	p. 58
<b>12</b>	<b>- Technical data .....</b>	<b>p. 59</b>
12.1	Transmitter UDE .....	p. 59
12.1.1	Technical characteristics .....	p. 59
12.1.2	Function button interlockings .....	p. 60
12.3	Standard battery UDB2 .....	p. 61
12.4	Fast charge battery UWB .....	p. 61
12.5	Receiver URR .....	p. 62
12.5.1	Receiver URR technical characteristics .....	p. 62
12.5.2	Fuse characteristics on receiver URR .....	p. 63
12.6	Receiver UCR .....	p. 64
12.6.1	Receiver UCR technical characteristics .....	p. 64
12.6.2	Fuse characteristics on receiver UCR .....	p. 65
12.7	Receiver UDR .....	p. 66
12.7.1	Receiver UDR technical characteristics .....	p. 66
12.7.2	Fuse characteristics on receiver UDR .....	p. 67
12.8	BNC plug-in antennas - use in 433-434MHz bands .....	p. 68
12.9	BNC plug-in antennas - use in 869MHz and 911-918MHz bands .....	p. 69
<b>13</b>	<b>- Servicing .....</b>	<b>p. 70</b>
13.1	Servicing the UDE transmitter .....	p. 70
13.2	Servicing the receiver URR/UCR/UDR .....	p. 70
<b>14</b>	<b>- FCC compliance .....</b>	<b>p. 71</b>
<b>15</b>	<b>- Warranty .....</b>	<b>p. 71</b>
<b>16</b>	<b>- Waste recycling and management .....</b>	<b>p. 72</b>
<b>17</b>	<b>- Product references .....</b>	<b>p. 72</b>
<b>18</b>	<b>- Warning, avoid any mutual disturbance .....</b>	<b>p. 72</b>
<b>19</b>	<b>- Manufacturer information .....</b>	<b>p. 72</b>
<b>20</b>	<b>- CE Declaration of conformity .....</b>	<b>p. 73</b>
20.1	Transmitter UDE .....	p. 73
20.2	Receiver URR .....	p. 74
20.3	Receiver UCR .....	p. 75
20.4	Receiver UDR .....	p. 76
<b>21</b>	<b>- FCC USA Certification documents .....</b>	<b>p. 77</b>
21.1	Transmitter UDEE .....	p. 77
21.2	Receiver UDRE .....	p. 78



***We thank you for your choice. You have just acquired the JAY Electronique UD Series radio control system, which offers you a configuration adapted to your application, easy to use and maintain, and with a high safety level.***

The JAY Electronique **UD Series** radio control system is intended to control industrial equipment, vehicles and lifting devices, previously operated by pendant control box or control panel.

The use of the radio control system enables the operator to better focus on his work as it allows him to choose his observation position which is only limited by safety considerations (example: no one should be standing under a load).

**The radio remote control does not remove, but completes and enhances the classic safety circuits (emergency stop circuits).**

The various components forming your JAY Electronique radio control system are designed to meet the safety requirements of the currently applicable and draft standards, and are compliant with the European directives (see section **«CE Declaration of conformity», page 73** ).

For all questions concerning installation or use of your radio control system, contact our «Customer Service» :



service: Monday to Friday

Tel : + 33 (0)4.76.41.44.00



Email : [customer.service@jay-electronique.com](mailto:customer.service@jay-electronique.com)

# 1 - General safety rules and precautions



## IMPORTANT :

A radio control system is considered as a machine control device and as a safety component used to stop a machine as specified by the EEC Machinery Directive.

**All applicable rules must therefore be observed to ensure safe, correct operation of such devices.**



The operator must be appropriately trained and certified to operate machines by radio control.



The operator must have uninterrupted visibility of the manoeuvre which he is performing. When the operator's direct field of view is inadequate, the lifting machinery must be equipped with auxiliary devices to improve visibility.



When several machines are being moved simultaneously, the equipment must be fitted out to limit to consequences of a possible collision.



To avoid any risks of electrocution, don't open the receiver housing when powered. The opening of the housing must be done by ensuring that the power supply cables and control cables are out of voltage.



Never leave the transmitter unattended in any haphazard location, even though it is equipped with a "Standby Mode" function which automatically cuts out the system, see section [«Standby mode» function», page 55](#)



Never leave the radio control transmitter on the ground. If doing so becomes indispensable, press the stop palmswitch on the radio control.



Never leave the transmitter to sunlight (eg vehicle windscreens), or near a heat source.



If several radio controls are used at the same site, different radio frequencies should be used, spaced by at least two channels (for example, channels 5, 7, 9,....). The more space there is between the chosen radio channels, the less the risks of disturbance are, see section [«Choice of operating radio frequency», page 39](#)



In the event of a malfunction, immediately shut down the installation by pressing the stop palmswitch on the transmitter, remove the electronic key and the battery.



For safety reasons, remove the electronic key when not in use. Store it in a safe and tracked down place.



The stop palmswitch button on transmitter should be manipulated to check if it is functional at minimum once a year.



Service your equipment and perform all the periodic checks as may be required by the intensity with which your equipment is used. Follow necessarily the instructions of cleaning described in the chapter [«Servicing», page 69](#)

## 2 - Description and operating principle

A radio control assembly is formed by two components :

a **transmitter** (UDE) + a **receiver** (for example : « UDR » type).

The transmitter transmits the commands to the receiver which operates its relay outputs according to a predefined button / relay assignment.

The type of the radio link between the transmitter and the receiver is unidirectional.

This link between the two elements is ensured and secured by means of an «identity code» (unique and fixed code for each product).

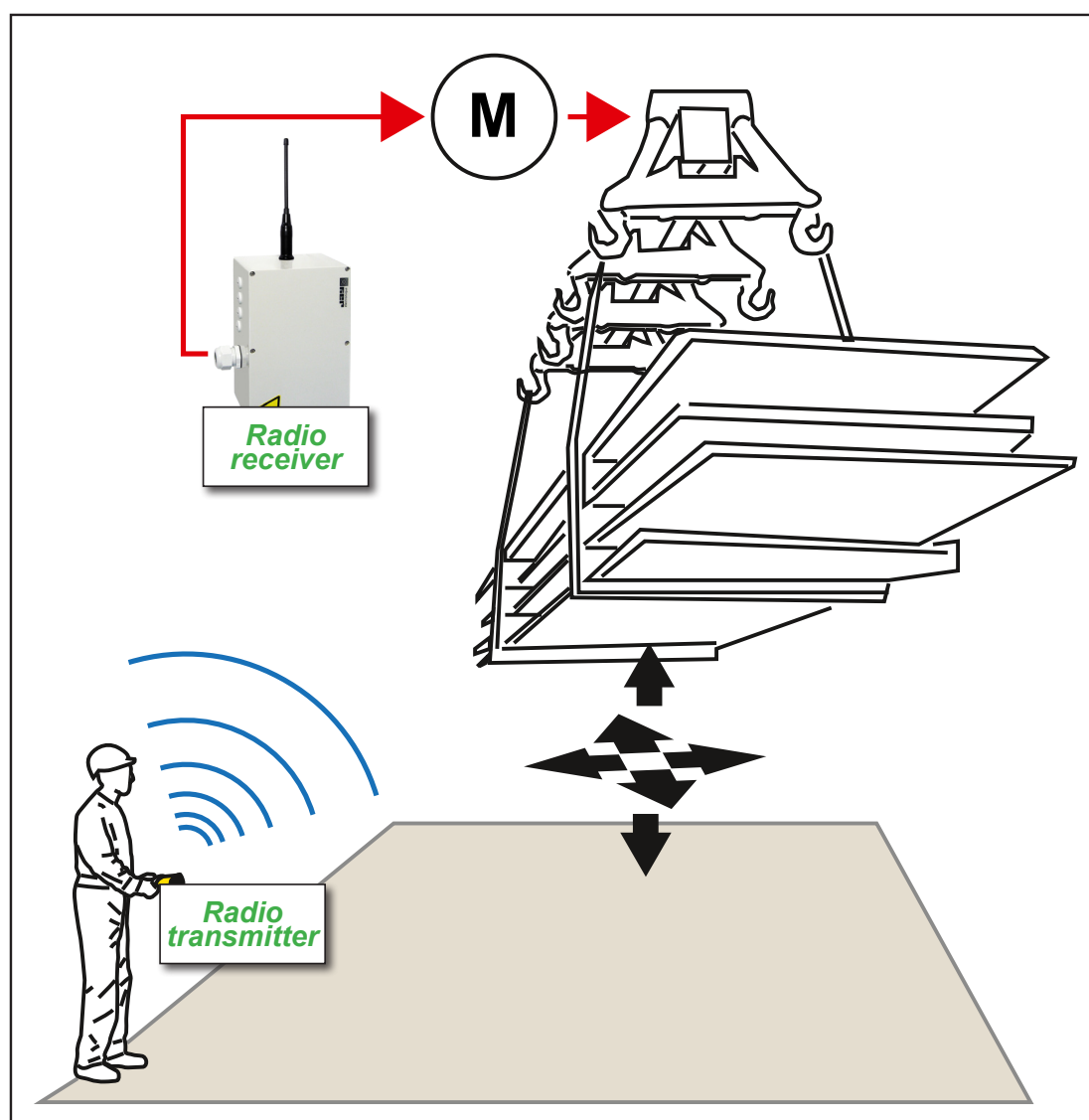

# 3 - Unpacking the elements

**IMPORTANT :** When unpacking the products, be sure to :

■ **Keep the «Quick Start Guide» supplied with the products ref.: 332750.**

A label is affixed to it, indicating various information about your configuration including «the electronic key number».

This number will allow you to order an identical electronic key with all the parameters of your radio remote control system.

This number is also written on the electronic key supplied with the product:

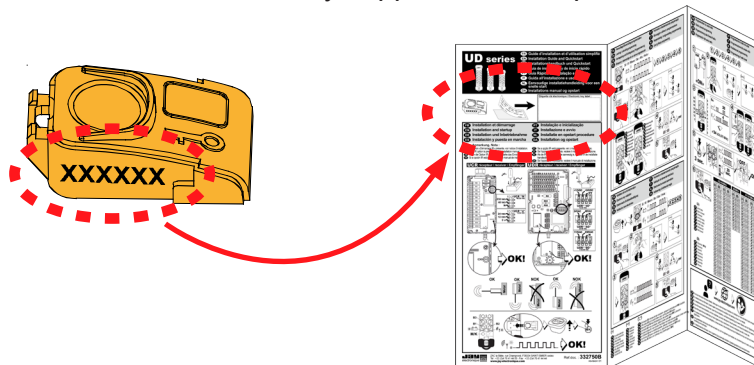

■ **Before a first use,** put the battery on load for 14 hours minimum (7 hours for battery ref.: **UWB**)



## Radio transmitter UDE

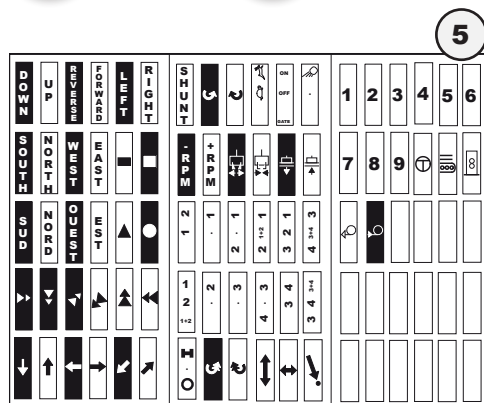
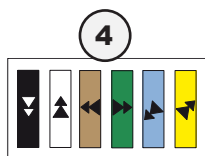
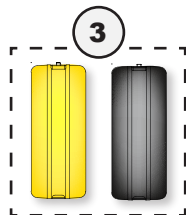
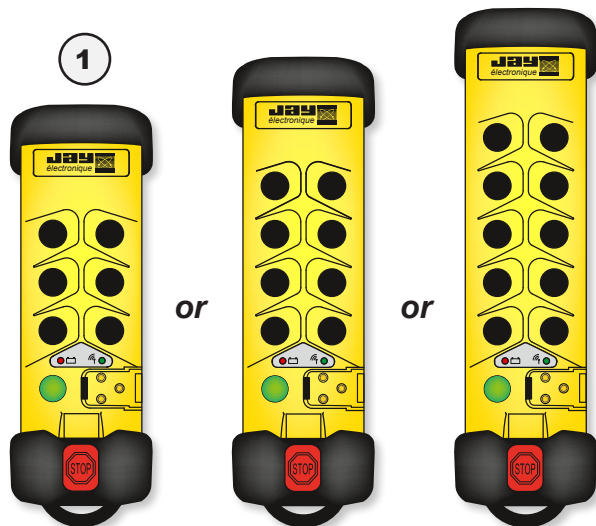

1. Radio transmitter **UDE** (depending on ordered model)
2. Electronic key (the key is delivered with the receiver in the case of a standard pack)
3. Battery : number and model according to choice made when ordering (pack, or separate element)  
Yellow = standard battery ref.: **UDB2**  
Black = fast charge battery ref.: **UWB**
4. Kit of colored labels «movements» for two-step pushbuttons (double speed) ref.: **UWE202**
5. Kit of black/white labels «movements, special and customization functions» for pushbuttons and switches ref.: **UWE207**



## (3 - Unpacking the elements)



### Radio receiver URR / UCR / UDR

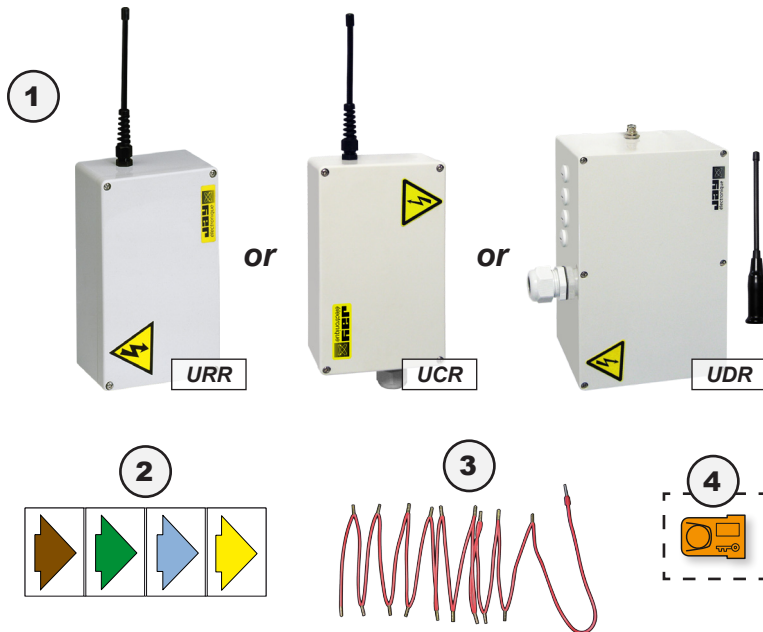

1. Radio receiver **URR** or **UCR** or **UDR** (depending on ordered model)
2. Self-adhesive directional colored arrows, to be stuck onto controlled equipment (e.g. travelling crane) ref.: **UWE002**
3. Common wiring accessory ref.: **UDWR12**
4. In the case of a standard pack, the electronic key is delivered with the receiver.



### Battery charger

(according choice made when ordering, standard pack or separate element)



or



or



1. Charger **UBCU** for battery **UDB2** (110-230 VAC / 12VDC)  
or  
Charger **UCCU** for battery **UWB** (110-230 VAC / 5VDC)

2. Connector **UBC1** for battery **UDB2**, to be connected to a stabilized power supply or car battery, 10 to 30VDC  
**Black/white wire : +**

3. Charger **UCC1** Voltage adapter on vehicle socket, to charge battery **UWB**



### Infrared module

Only for an option requiring the use of an infrared signal.

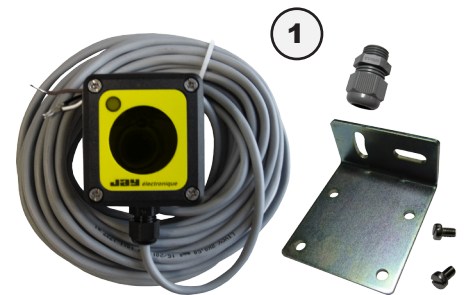

1. Infrared module ref.: **UDF1**, delivered with M16 cable gland and mounting bracket.

## 4 - Description of elements

### 4.1 Transmitter UDE

3 models are available :

**6** function buttons, **8** function buttons or **10** function buttons.

Each model also contains **1** green «On/Horn» button and **1** Stop palmswitch button.

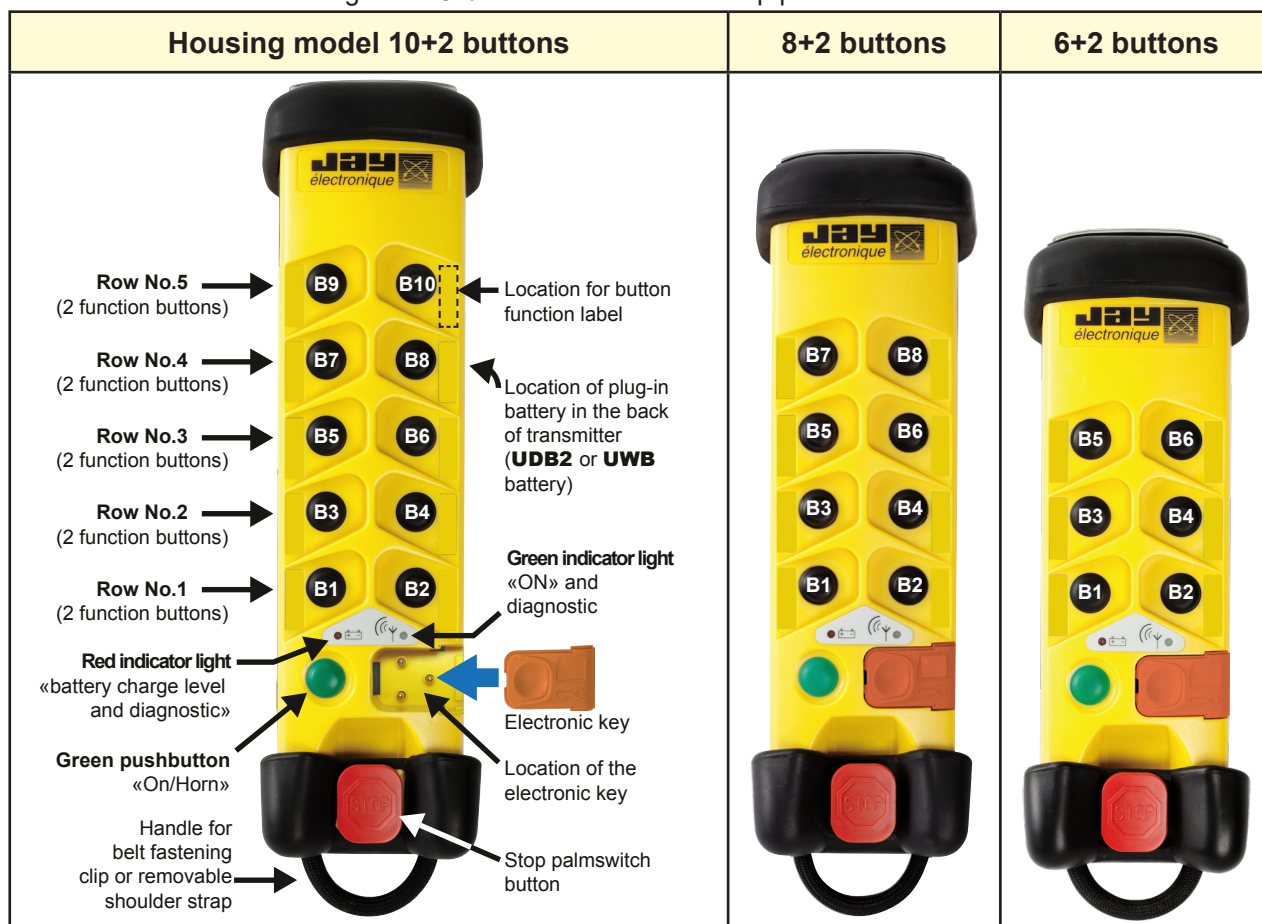

Different types of function buttons are available :

- **BPSV** = single speed pushbutton (One-step pushbutton)
- **BPDV** = double speed pushbutton (Two-step pushbutton)
- **COM2** = Rotary switch with 2 fixed positions
- **COM3** = Rotary switch with 3 fixed positions
- **COM3R** = Rotary switch with 3 positions with automatic return
- **BPTR** = Electronic switch with 3 fixed positions

The **electronic key** is to be inserted into the transmitter housing. This key contains all the parameters of the controlled receiver. It is possible to customize a backup transmitter only with an electronic key and a validation procedure.

For more information, see the section [«Electronic key», page 14](#)

Two parameters can be easily adapted to the environment by a trained operator :

- Operating radio frequency,
- Duration of temporization for «Standby mode» function (Automatic shutdown of remote control in case of prolonged non use).

These operations are performed by procedures implementing buttons B1, B2, B3, the stop palmswitch button and the «On/Horn» button, with no need to open the transmitter or receiver.

The change of parameter can be however locked..

See section [«Configuration and Parameterization», page 41](#)

## (4 - Description of elements)

### 4.1.1 Labeling the transmitter function buttons

The various button functions are identified by means of adhesive labels, to be stuck onto the transmitter housing, at each button location.

The labels are delivered in the form of boards to be used depending on the application.

**Kit of 90 black/white labels «movements, special and customization functions» for pushbuttons and switches**

Reference : **UWE207** (supplied as standard with the transmitter UDE)

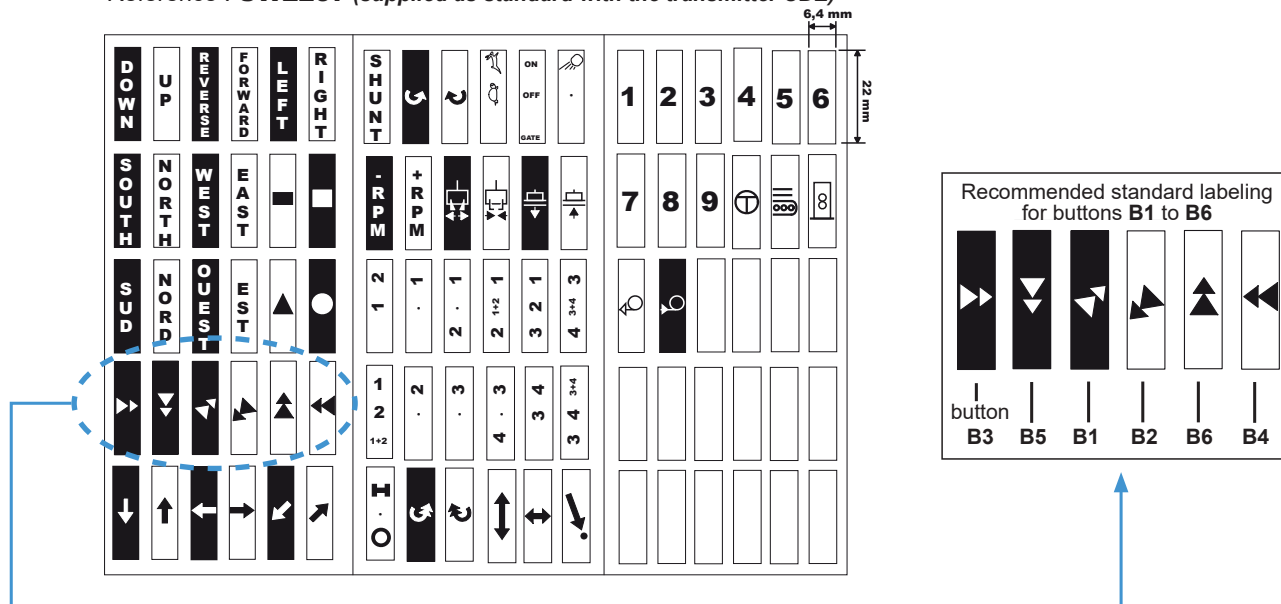

**Kit of 6 colored labels «movements» for two-step pushbuttons (double speed)**

Reference : **UWE202** (supplied as standard with the transmitter UDE)

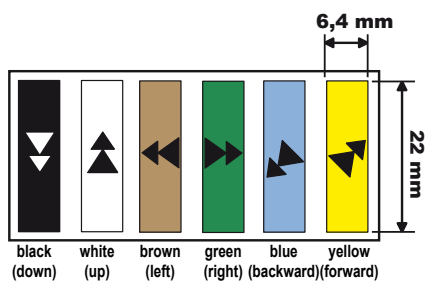

Other label sheets available:

**Kit of 48 blank labels (white) + 48 transparent labels for personalized labeling**



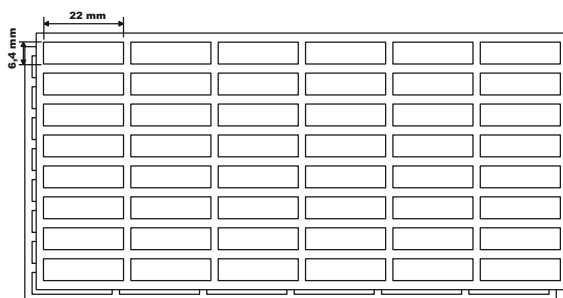

Reference : **UWE205**

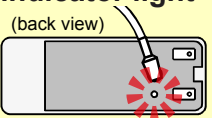

## (4 - Description of elements)

### 4.2 Chargers and batteries

2 battery types can be used with the transmitter: **UDE** :

Batteries	 <b>Dedicated chargers</b> (important: only the JAY Electronics chargers listed below are suitable for recharging the batteries)	<b>Battery indicator light</b> (back view) 
 Battery ref.: <b>UDB2</b> Standard battery Power supply 10 to 30VDC (full charge in 14h)	 Charger <b>UBCU</b> Input : 110-230VAC Output : 12VDC  Connector <b>UBC1</b> to be connected to a stabilized power supply or car battery, 10 to 30VDC Black/white wire : +	<b>RED</b> indicator light «in charge» (This indicator light does not show the charge level)
 Battery ref.: <b>UWB</b> Fast charge battery Power supply 5VDC (full charge in 7h)	 Charger <b>UCCU</b> Input : 110-230VAC Output : 5VDC  Charger <b>UCC1</b> On vehicle socket Input : 12 to 24VDC Output : 5VDC	<b>ORANGE</b> indicator light (fast charge) this light turns <b>GREEN</b> for the holding charge (the battery has been recharged at + 60%)

#### 4.2.1 Battery storage precaution and general information

The battery must be stored in a clean, dry place at the temperatures specified in the table under section «**Standard battery UDB2**», page 61.

Self-discharge is estimated at 15% the first month and then low (it is mandatory to recharge the battery pack every 6 months mini.). The number of full charge cycles is 500 minimum for battery **UDB2** and 300 minimum for battery **UWB** (without damaging the battery capacity).

#### 4.2.2 Precaution when inserting battery pack in transmitter unit

After any change, check that the battery is correctly held in the location provided on the back of the transmitter.

If not, a 5-blink error message caused by micro-power failures may occur (according to fault list generated by the transmitter)

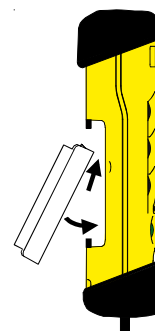

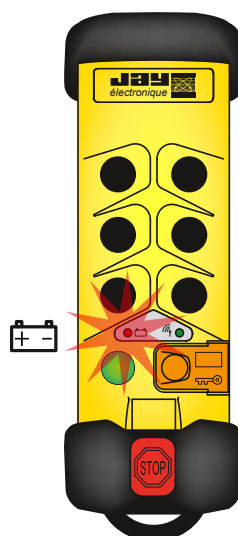

## (4 - Description of elements)

### 4.2.3 Indication of remaining battery level



Two battery charge status display functions are provided on the transmitter:

1. **When the remote control is powered up** (stop palmswitch button out), the red indicator light on the transmitter shows the remaining battery level:

Status of the RED indicator light	Battery charge status
Red indicator light off	Battery charge > 90%
Red indicator light flashes slowly 	Battery charge between 90% and 10%
Red indicator light flashes quickly 	Battery charge < 10% The battery pack must absolutely be charged

2. **During operation of the remote control** (radio transmission), a **LOW BATT** (battery low level, charge < 10%) indication is given by the red indicator light which flashes quickly. This indication is used to inform the operator that the remote control will soon be unavailable (within around 15 minutes).

## (4 - Description of elements)

### 4.3 Electronic key

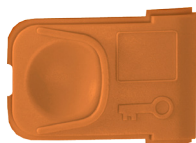

The electronic key used on the UD radio remote control system has a dual function :

- It enables start-up of the transmitter by limiting access to the remote control to trained and authorized persons only.
- It contains all the information required for operation of the product, including:
  - ◇ the system identity code
  - ◇ the last programmed frequency \*
  - ◇ the «Standby Mode» function duration \*
  - ◇ the transmitter button configuration and the type of button used (push or rotary type)
  - ◇ and the option register

When the key is removed, it prevents unauthorized use of the transmitter. For this reason, it should be removed (like the battery) when the remote control is put away.

Preferably, the electronic key should be removed after pressing the stop palmswitch button. Removal of the key before the stop palmswitch button is pressed will result in a fault indication (2 flashes) and passive shutdown of the receiver.

If necessary, it can be used to stop the system.

\* = reprogrammable by a trained operator, see section [«Configuration and Parameterization», page 41](#)



**The transmitter cannot be started up without its electronic key**

The transmitter **UDE** also has an internal memory containing an identity code.

- If identity code of the electronic key matches the identity code stored in the **UDE**, the transmitter can be started up.
- If the identity code of the electronic key and that of the UDE do not match, the transmitter indicates the problem by its two indicator lights (3 flashes). In this case, perform the programming procedure described in section [«Procedure : Recopying the electronic key identity code», page 45](#)

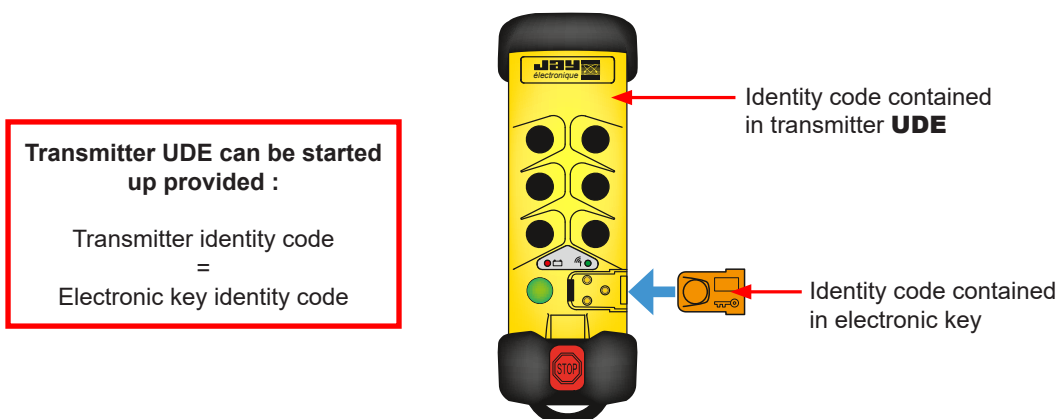

## (4 - Description of elements)

### In the event of a transmitter failure :

You can recover the electronic key and connect it on a backup transmitter (button configuration should be the same as that of the failed transmitter, otherwise, buttons that are different will be ineffective).

To perform this operation, you must reprogram the key identity code in the new transmitter **UDE**, as described in the procedure in section [«Procedure : Recopying the electronic key identity code», page 45](#)

---

### if your electronic key is lost :

You can order another electronic key (ref.: **UDWE23**) making sure to specify the following information when ordering :

- Unique 6-digit number of the old key (information indicated on the label stuck onto the «Quick Start Guide»).

or, if you do not have key number :

- the associated receiver identity code (on receiver descriptive label)  
and
- the transmitter button configuration **UDE**.

This information will allow you to receive an electronic key identical to the old one containing all the parameters indicated above for your radio remote control.

## (4 - Description of elements)

### 4.4 Receiver URR

The receiver is formed by a basic PCB comprising 6 control relays.

The basic board systematically comprises :

- **1 «Horn» relay** (active when the transmitter «On/Horn» button is pressed, not auto-maintained)
  - **2 safety relays** (active when the transmitter «On/Horn» button is pressed, auto-maintained until passive or active stop)
- 1 infrared module ref.: UDF can be connected to the receiver for the option **«start-up by IR validation option», page 56**
- 3 models depending on power supply : 12-24 VDC, 24-48 VAC or 115-230 VAC
- 1 standard relay configuration (see section **Standard unit using receiver URR», page 31**)

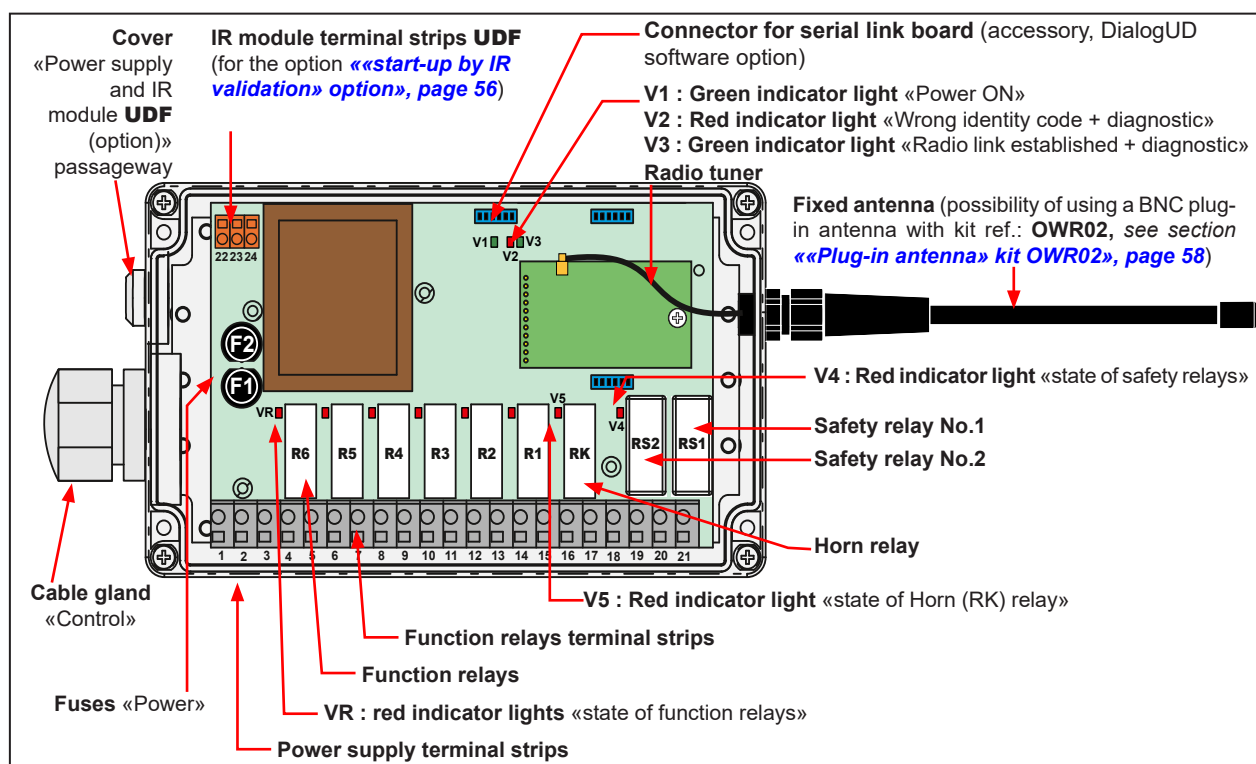

Terminal number	Function
1	Neutral or 0 V (depending power supply version, see section <a href="#">«Installation»</a> )
2	115 VAC or 24 VAC or 24 VDC (depending power supply version, see section <a href="#">«Installation»</a> )
3	230 VAC or 48 VAC or 12 VDC (depending power supply version, see section <a href="#">«Installation»</a> )
4 - 5	Function relay R6
6 - 7	Function relay R5
8 - 9	Function relay R4
10 - 11	Function relay R3
12 - 13	Function relay R2
14 - 15	Function relay R1
16 - 17	«Horn» relay RK (controlled by the green button of the transmitter UDE)
18 - 19	Safety relay No.2 RS2
20 - 21	Safety relay No.1 RS1
22	Terminal block for option «start-up by IR», Infrared module UDF - White wire
23	Terminal block for option «start-up by IR», Infrared module UDF - Brown or Blue wire
24	Terminal block for option «start-up by IR», Infrared module UDF - Black wire



## (4 - Description of elements)

### 4.5 Receiver UCR

The receiver is formed by a basic PCB comprising 12 control relays.

The basic board systematically comprises :

- **1 «Horn» relay** (active when the transmitter «On/Horn» button is pressed, not auto-maintained)
- **2 safety relays** (active when the transmitter «On/Horn» button is pressed, auto-maintained until passive or active stop)

- 2 models depending on power supply : 12-24 VDC, 48-230 VAC

- 4 types of relay configuration depending on the transmitter to which the receiver is associated (see chapter «[Standard units using receiver UCR](#)», page 32)

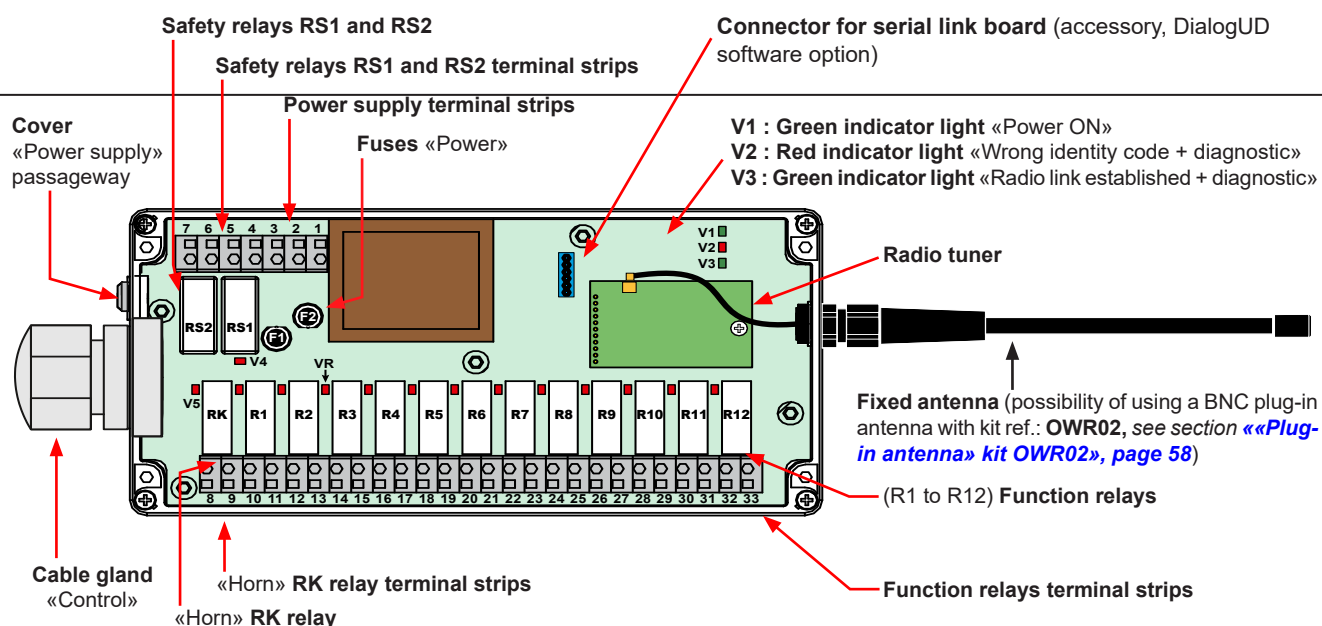

Terminal number	Function
1	Neutral or 0 V (depending power supply version, see section « <a href="#">Installation</a> »)
2	48 VAC or 12 VDC (depending power supply version, see section « <a href="#">Installation</a> »)
3	230 VAC or 24 VDC (depending power supply version, see section « <a href="#">Installation</a> »)
4 - 5	Safety relay No.1 RS1
6 - 7	Safety relay No.2 RS2
8 - 9	«Horn» RK relay (controlled by the green button of the transmitter UDE)
10 - 11	Function relay R1
12 - 13	Function relay R2
14 - 15	Function relay R3
16 - 17	Function relay R4
18 - 19	Function relay R5
20 - 21	Function relay R6
22 - 23	Function relay R7
24 - 25	Function relay R8
26 - 27	Function relay R9
28 - 29	Function relay R10
30 - 31	Function relay R11
32 - 33	Function relay R12

## (4 - Description of elements)

### 4.6 Receiver UDR

The receiver is formed by a basic board on which the following components can be connected :

- 2 to 3 boards with 6 control relays
- 1 RS232 serial link board for diagnostic and programming purposes (option and accessory)

The basic board systematically comprises :

- 1 «Horn» relay (active when the transmitter «On/Horn» button is pressed, not auto-maintained)
- 2 safety relays (active when the transmitter «On/Horn» button is pressed, auto-maintained until passive or active stop)

- Up to 3 infrared modules ref. : **UDF** can be connected to the receiver for option using an infrared signal.
- 3 models depending on power supply : 12-24 VDC, 24-48 VAC or 115-230 VAC
- 4 types of relay configuration depending on the transmitter to which the receiver is associated (see chapter «Standard units using receiver UDR», page 35)

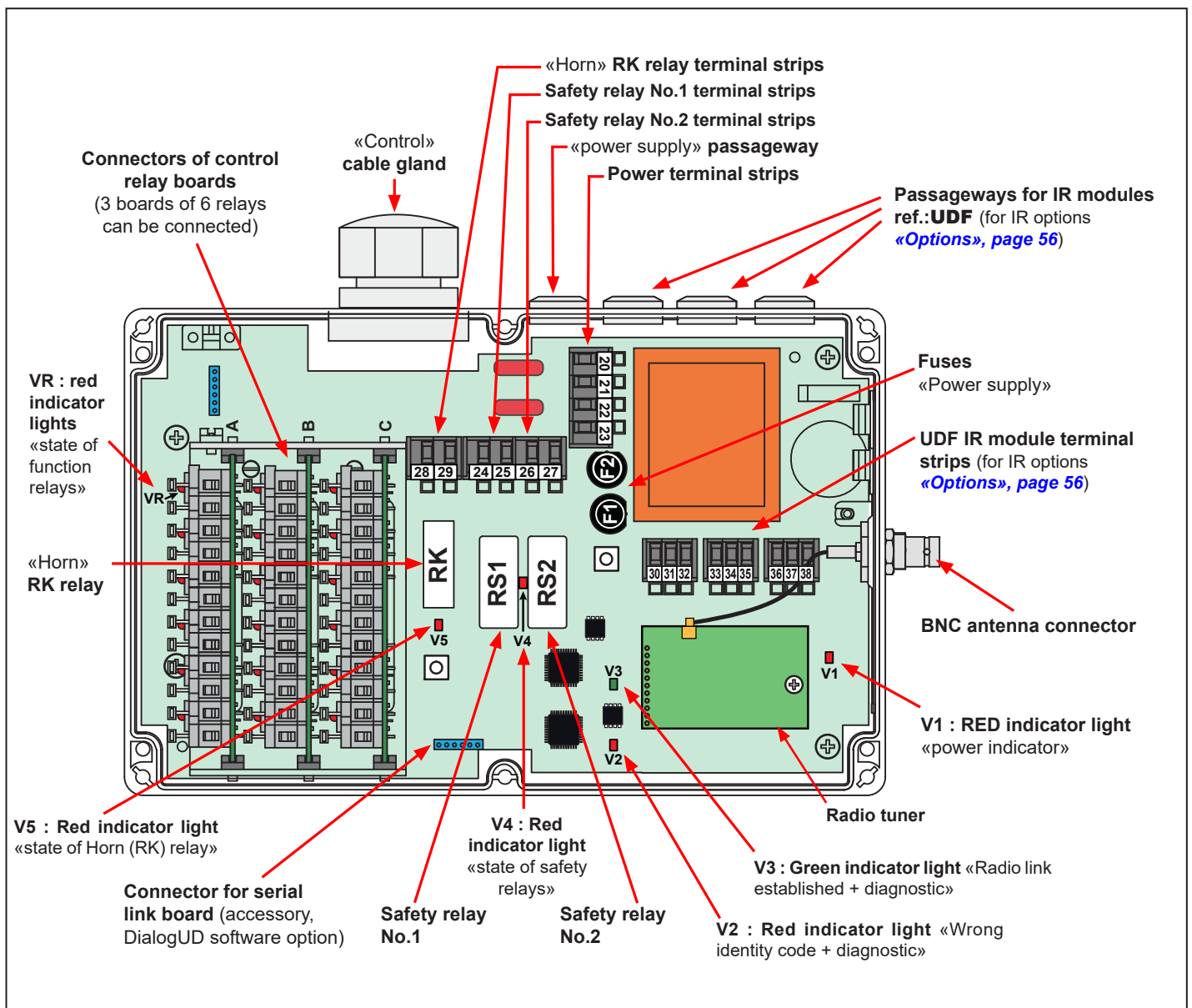

## (4 - Description of elements)

Terminal number	Function
3 x 1 to 12	Function relay boards (A, B, C Locations)
21	Neutral or 0 V (depending power supply version, see section <a href="#">«Installation»</a> )
22	230 VAC or 48 VAC or 24 VDC (depending power supply version, see section <a href="#">«Installation»</a> )
23	115 VAC or 24 VAC or 12 VDC (depending power supply version, see section <a href="#">«Installation»</a> )
24 - 25	Safety relay No.1 RS1
26 - 27	Safety relay No.2 RS2
28 - 29	«Horn» RK relay (controlled by the green button of the transmitter UDE)
30	(IR Option) infrared module UDF No.1 - white wire
31	(IR Option) infrared module UDF No.1 - brown or blue wire
32	(IR Option) infrared module UDF No.1 - black wire
33	(IR Option) infrared module UDF No.2 - white wire
34	(IR Option) infrared module UDF No.2 - brown or blue wire
35	(IR Option) infrared module UDF No.2 - black wire
36	(IR Option) infrared module UDF No.3 - white wire
37	(IR Option) infrared module UDF No.3 - brown or blue wire
38	(IR Option) infrared module UDF No.3 - black wire

## 5 - Delivery configuration

### Radio channel number :

- For standard packs, the pre-programmed radio channel is 01 (see chapter [«Radio frequency tables», page 40](#))
  - For separated elements, the radio channel conforms to the definition of the hardware when ordering (transmitter sale reference)
- 

### Duration of the temporization for the «Standby mode» function (automatic shutdown of remote control in case of prolonged non-use) :

- Programmed for 4mn
- 

### Button / relay configuration and button interlocking :

- For standard packs, see section [«Wiring diagrams and assignment of buttons/relays for standard assemblies», page 31](#)
  - For separated elements, these configurations conform to the definition of the hardware when ordering, standard or special (customization sheet).
- 

### Locking of the UDE transmitter electronic key (access to UDE transmitter programming) :

- The electronic key is delivered «unlocked», the following parameters can be directly programmed by a trained and authorized operator (see operating procedures in chapter [«Configuration and Parameterization», page 41](#)) :
  - Radio frequency (number of the radio channel),
  - Duration of the temporization for the «Standby mode» function

# 6 - Installation

## 6.1 Installation recommendations

Experience shows that the functional efficiency of the system basically depends on the quality of the installation :

- Implementation of elements,
- Marking of the controlled equipment,
- Wiring quality of receiver and UDF infrared module (for options using an infrared signal),
- Interference suppression,
- Electrical power supply protection,
- Minimum and maximum current of relay outputs,
- Choice of operating radio frequency.

## 6.2 Dimension and implementation of elements

The following symbol  indicates essential information for the mounting holes.

### 6.2.1 Receiver URR

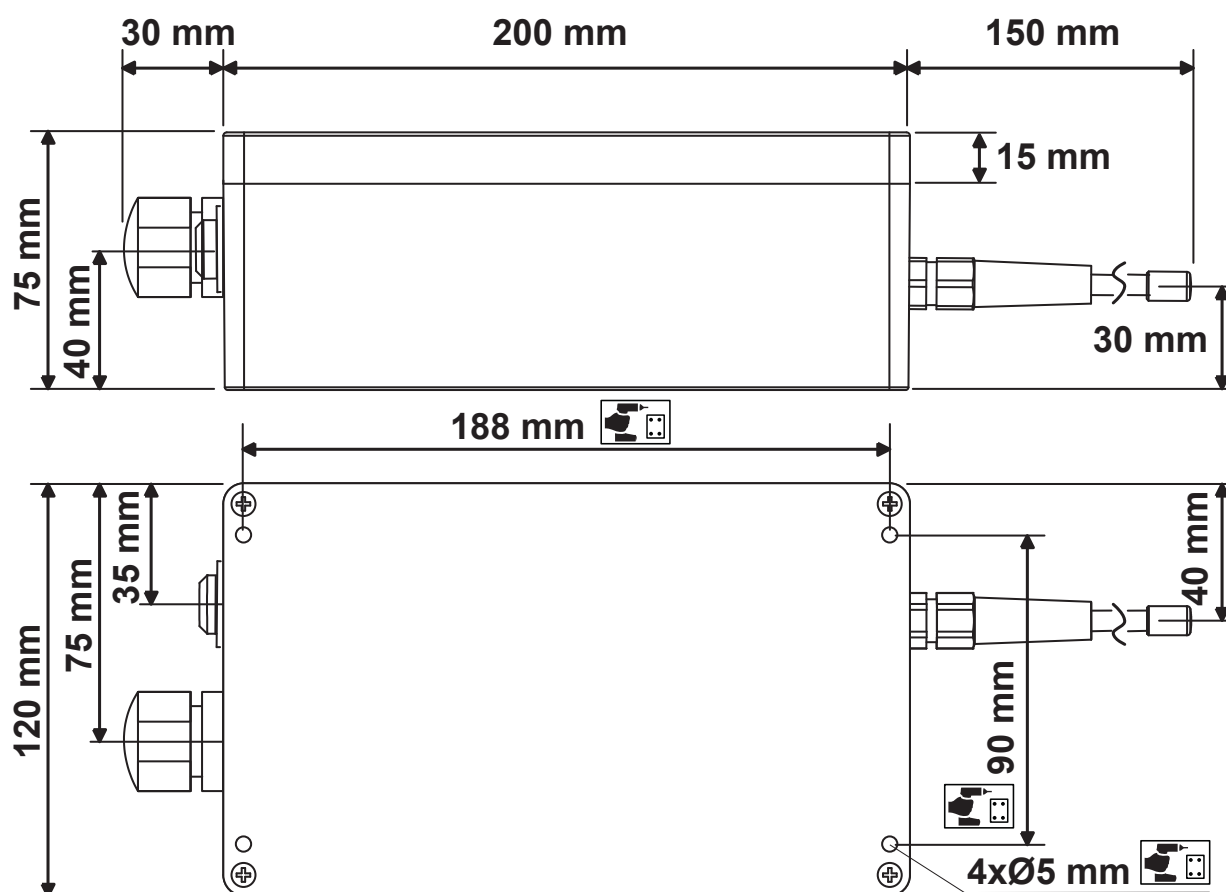

## (6 - Installation)

### 6.2.2 Receiver UCR

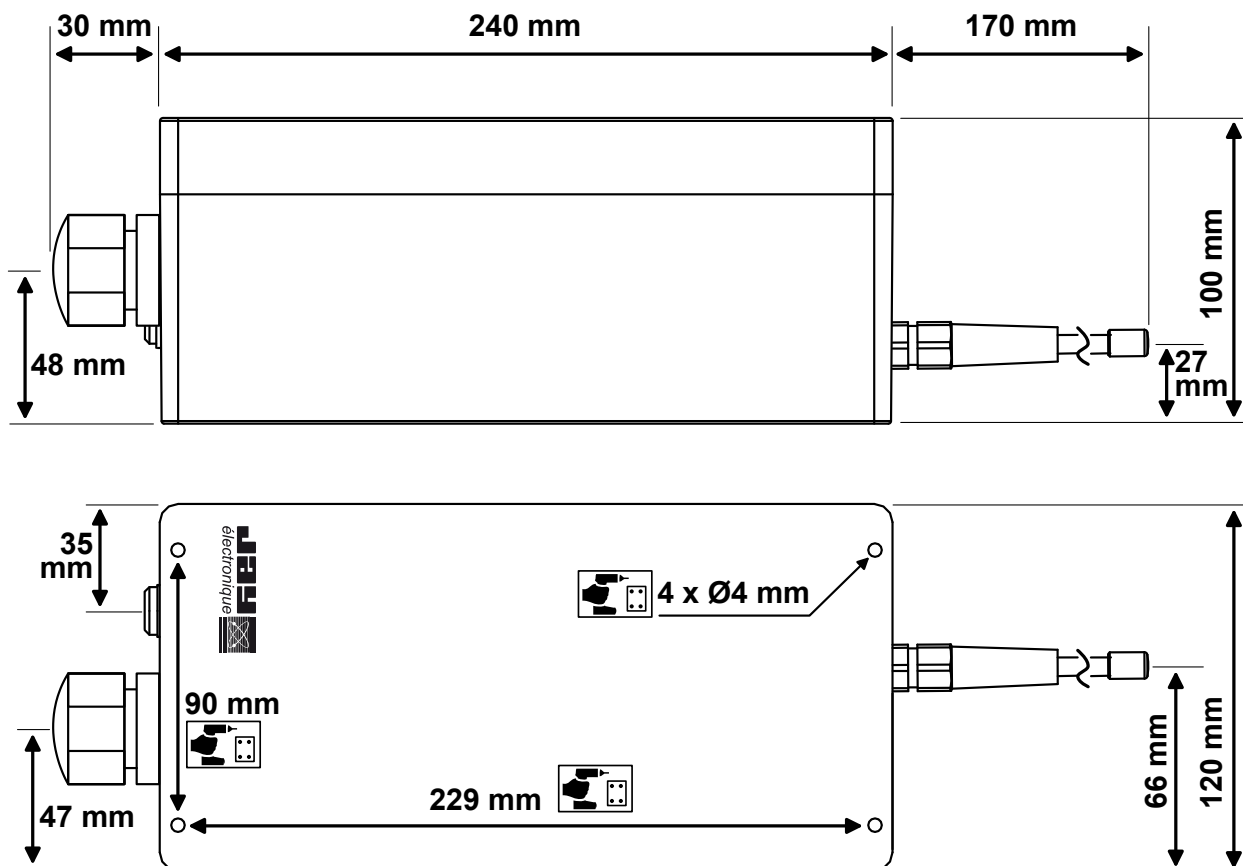

### 6.2.3 Receiver UDR

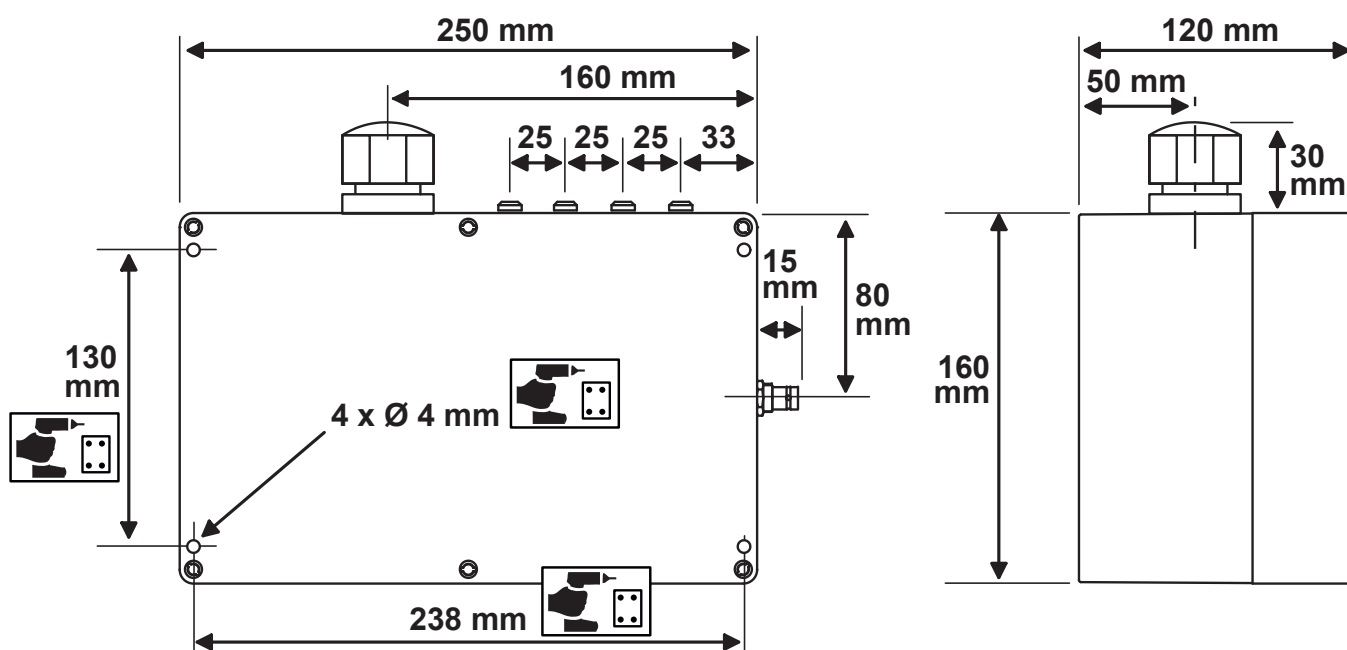

## (6 - Installation)

### 6.2.4 Infrared module UDF

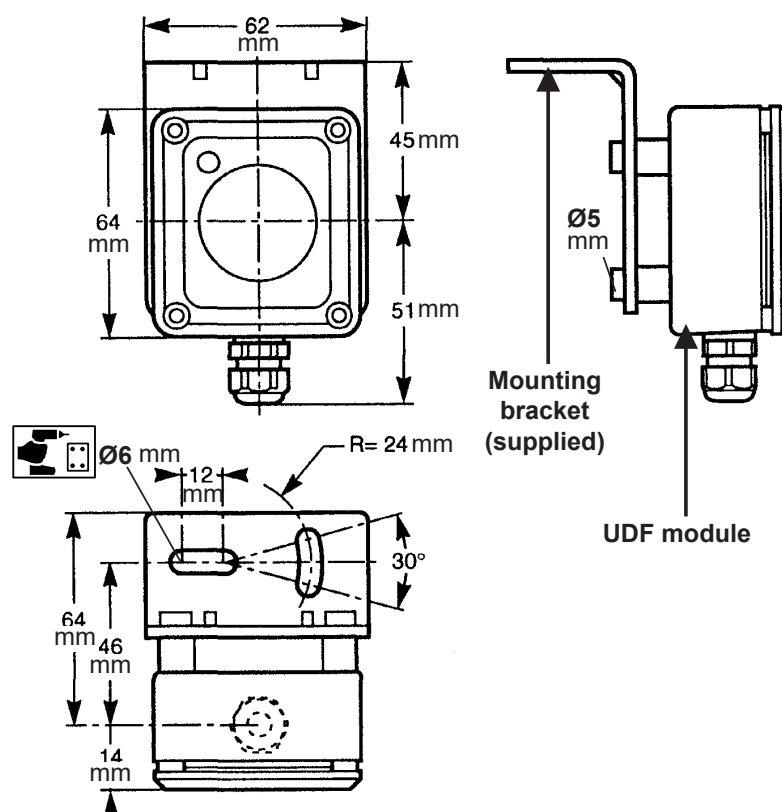

### 6.2.5 Wall Bracket UDC1 for transmitter and battery

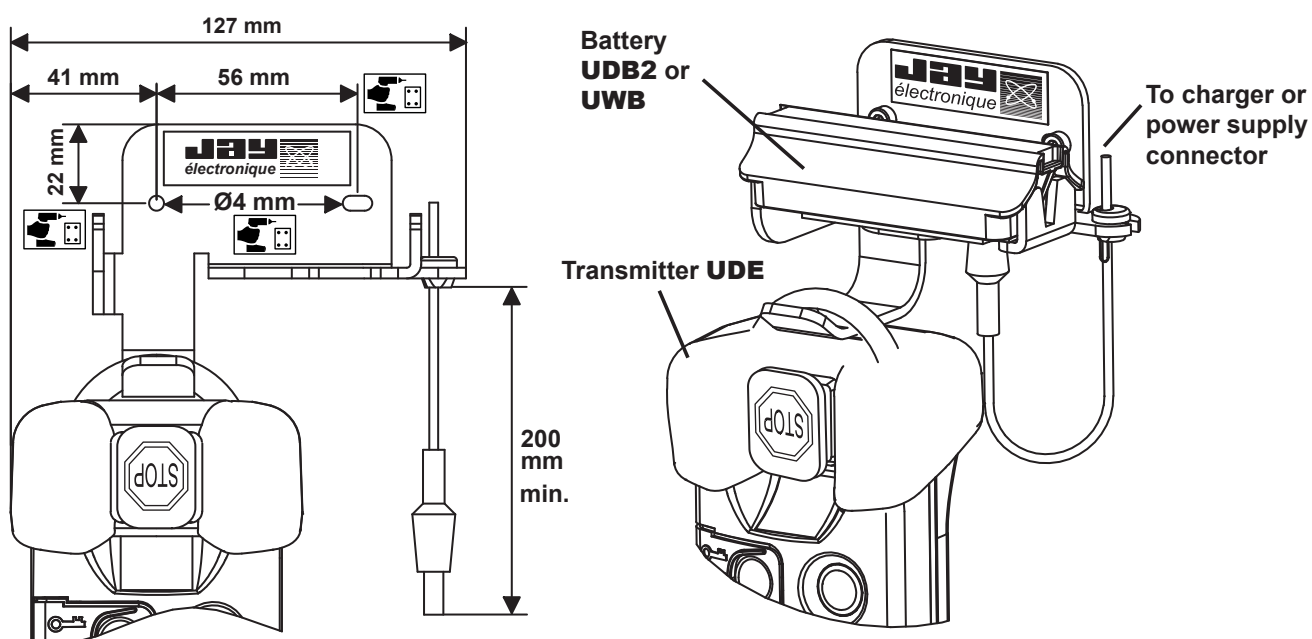

## (6 - Installation)

### 6.2.6 Transmitter UDE

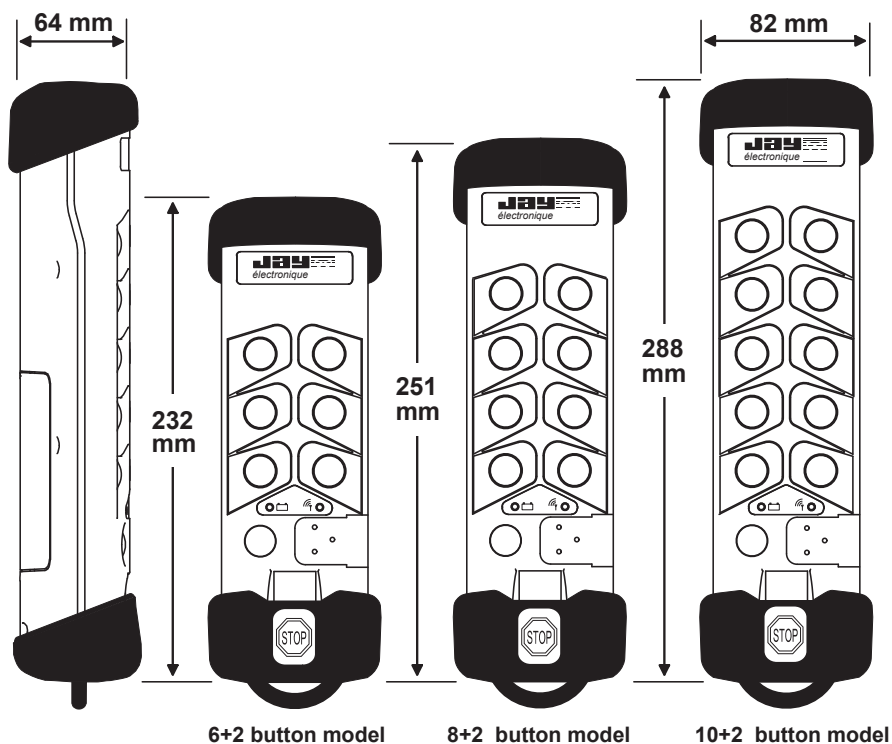

### 6.2.7 Charger, voltage adapter and connector (to charge battery UDB2 or UWB)

**UBCU** To charge battery **UDB2**  
110-230 VAC / 12VDC,  
with EU, UK and US plugs

**UCCU** To charge battery **UWB**  
110-230 VAC / 5VDC,  
with EU, UK and US plugs

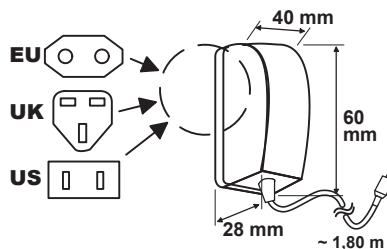

**UBC1** To charge battery **UDB2**  
Connector to be connected  
to a stabilized power supply  
or a car battery, 10 to 30  
VDC

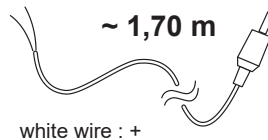

**UCC1** To charge battery **UWB**  
Voltage adapter on vehicle  
socket.  
12-24VDC / 5VDC

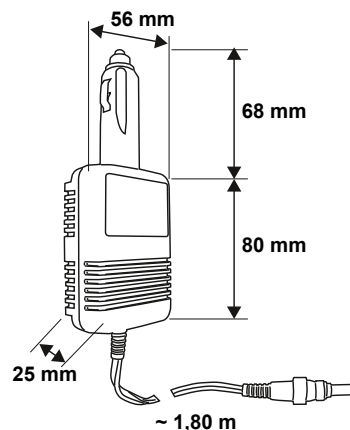



## (6 - Installation)

### 6.3 Receiver position

The remote control receiver should be mounted as close as possible to the control cabinet, vertical with respect to the machine structure. The receiver should be sheltered from shocks and weather.

The antenna should be as far as possible from the class 3 cables and power components (power supply, motor, variable speed drive, etc.) while remaining within an area favorable to radio reception (and connection of the UDF infrared module(s), if the remote control is equipped with an IR option).

- The antenna should be located at a height, above the operator using the transmitter. No metal object which could create a screen should be located between the operator and the antenna.
- The antenna must be directed toward the transmitter working areas (downward with a hoist).
- The correct orientation of the antenna is shown in the figure below :

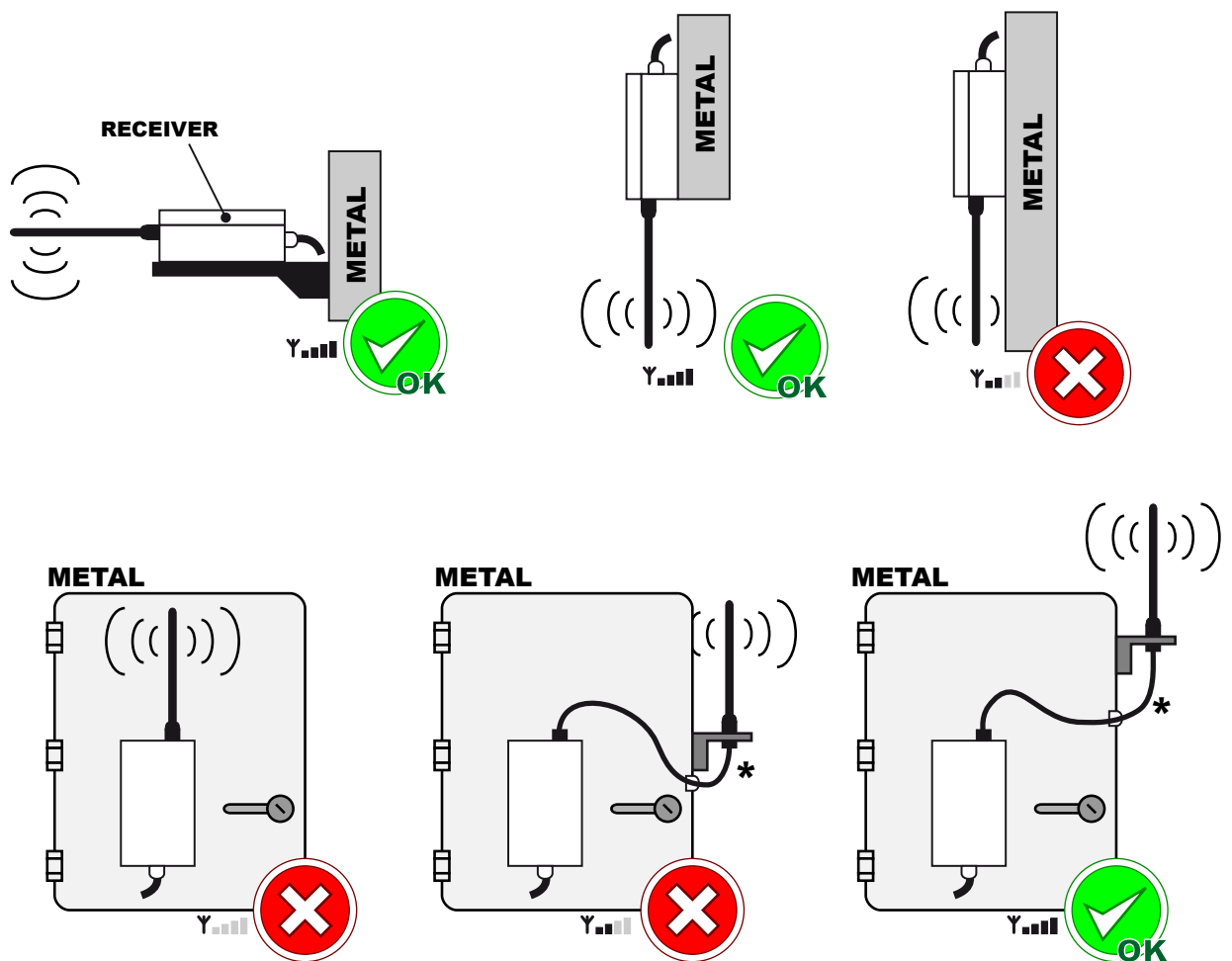

\* For the **URR** and **UCR** receivers, it is possible to use a removable antenna BNC and extension antenna thanks to kit ref. : **OWR02**. See chapter «*Plug-in antenna*» kit **OWR02**», page 58

## (6 - Installation)

### 6.4 UDF infrared module position (option)

See chapter «*Options*», page 56 for the description, installation and use of options using an infrared signal.

### 6.5 Marking the Controlled Equipment

If there are several equipment fitted with similar radio remote control systems working in the same neighbourhood (e.g. in a plant), each transmitter and each electronic key shall carry a clear indication which tells the equipment driver which equipment is controlled by the transmitter in question.

In this respect, signalling arrows are available as an accessory.

Place the different arrows on the equipment to be controlled so that each arrow colour corresponds to that on the associated transmitter control button.

The direction of movement of control buttons shall whenever possible be consistent with equipment motion. Symbols shall be fixed in such positions that there is a clear and unambiguous relationship between the action on buttons in the control station and the corresponding direction of motion.

#### 4 Self-adhesive directional colored arrows

Reference : **UWE002** (label sheet supplied as standard with the receiver)

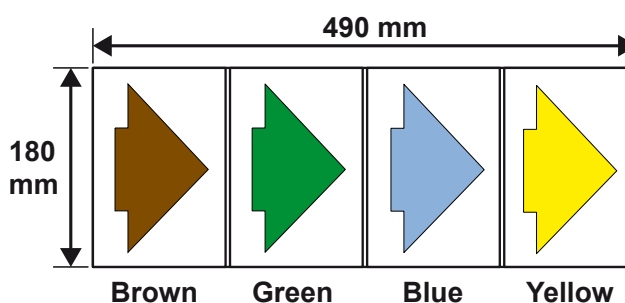

### 6.6 Auxiliary control

Measures should be taken to ensure, that when the radio control is not in service, another control system can be used to ensure the safety of the operator and the manipulated load.

## (6 - Installation)

### 6.7 Wiring the radio receiver

#### 6.7.1 Instructions for electrical connection of the receiver



To avoid any risks of electrocution, don't open the receiver housing when powered. The opening of the housing must be done by ensuring that the power supply cables and control cables are out of voltage.

- The receiver power supply circuit must be directly related to the power supply circuit of the radio-controlled equipment.
- The receiver power supply circuit must have appropriate separation means (fuse(s) or circuit breaker) or benefit from the power supply circuit of radio-controlled equipment.
- When the receiver is supplied with 230 VAC, the power cable shall be separated from the «control» cable. In the case of use of EEC-type electrical plug, the color of the plug shall be "BLUE".
- In cable path, power cables should be separated from the control cables, by observing a minimum spacing (20 cm) between the various classes :
  - **Class 1** : Radio, analog signals
  - **Class 2** : Mains for supply of various components,
  - **Class 3** : Power control of motors, variable speed drives, etc...If only one cable path is available, the cables of different classes should be separated as much as possible
- To maintain the reinforced insulation inside the receiver housing, it is mandatory to increase the insulation of cables carrying high voltages with insulating sleeves.
- Be sure not to exceed the minimum and maximum characteristics specified in chapter [«Technical data», page 59](#), by installing, if necessary, an additional load or intermediate relays (auxiliary contacts in electrical control cabinet for power control, for example).
- When flexible multi-strand wires are used, wire end ferrules must be used to avoid false contacts and short-circuits.



## (6 - Installation)

### 6.7.2 Conductor wire sections to be observed

Be sure to observe the min. /max. wire sections listed below for electrical connection of the receiver :

<ul style="list-style-type: none"><li>- Receiver power supply circuit</li><li>- Connection to function relays</li><li>- Connection to safety relays</li></ul>	0,5mm <sup>2</sup> to 1,5mm <sup>2</sup>
---	--

### 6.7.3 Opening the connection terminal strips on receivers URR and UCR

To open the connection terminal strips :

1. Insert a screwdriver vertically (flat blade 1.5 to 3 mm wide) into the slot on the terminal block,
2. Exercise a moderated pressure up to opening the terminal,
3. Insert the wire,
4. Remove the screwdriver.

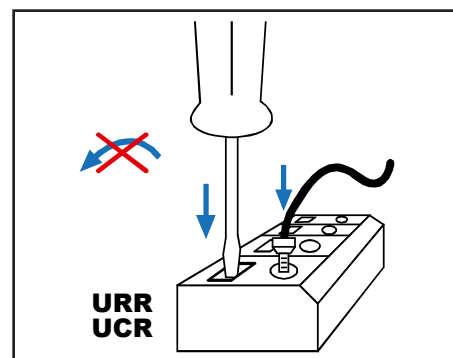

### 6.7.4 Opening the connection terminal strips on receiver UDR

To open the connection terminal strips :

1. Insert a screwdriver vertically (flat blade 1.5 to 3 mm wide) into the slot on the lever,
2. Exercise a moderated pressure up to opening the terminal,
3. Insert the wire,
4. Remove the screwdriver.

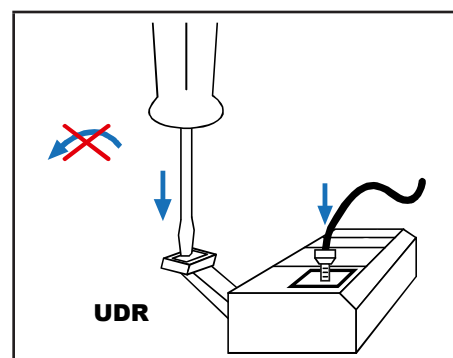

# (6 - Installation)

## 6.7.5 Wiring the power supply



### Attention:

The electrical connection of the power supply must be made in such a way that when the main switch is deactivated, the receiver of the radio control unit is also deactivated.

**Receiver URR**

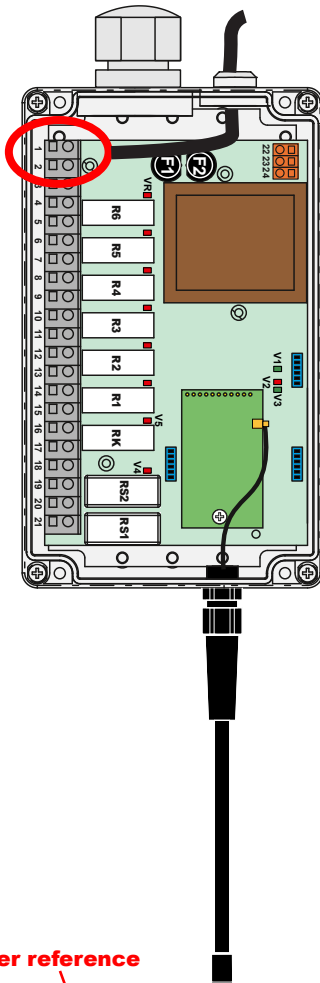

**Receiver UCR**

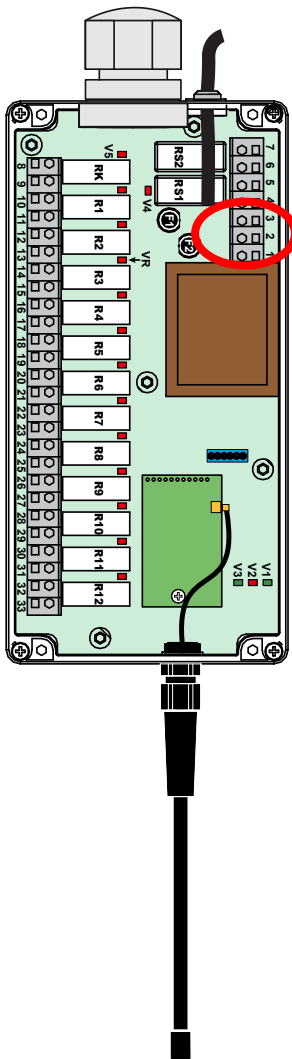

**Receiver UDR**

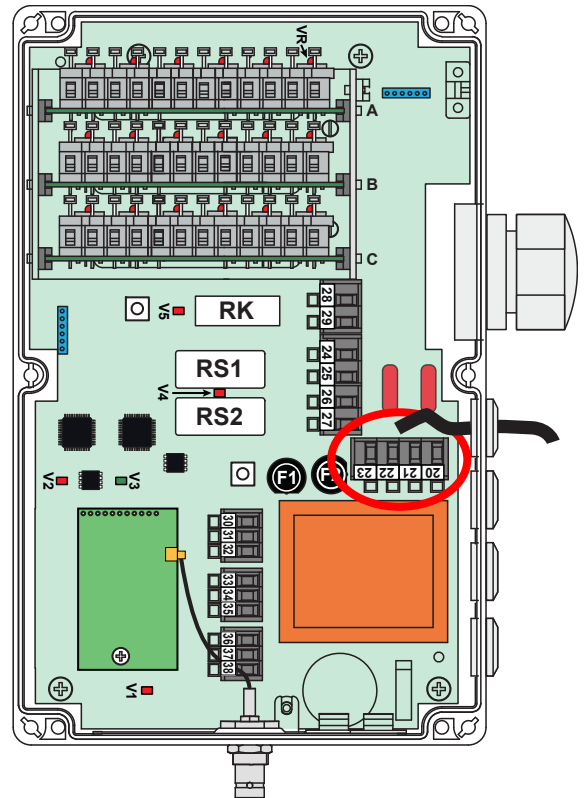

Receiver reference

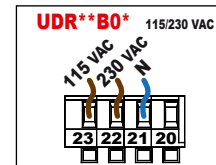
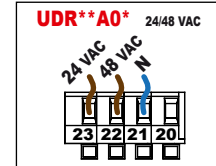
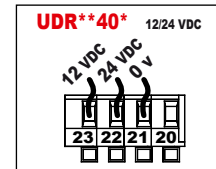
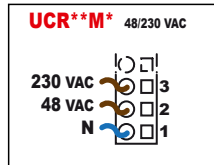
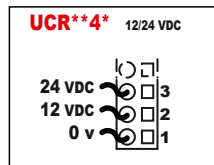
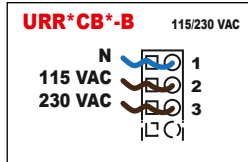
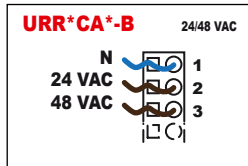
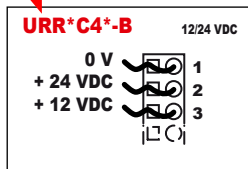

## (6 - Installation)

### 6.7.6 Use of safety relays RS1 and RS2

The safety relays **RS1** and **RS2** are used to interrupt the common control line of the radio-controlled equipment :

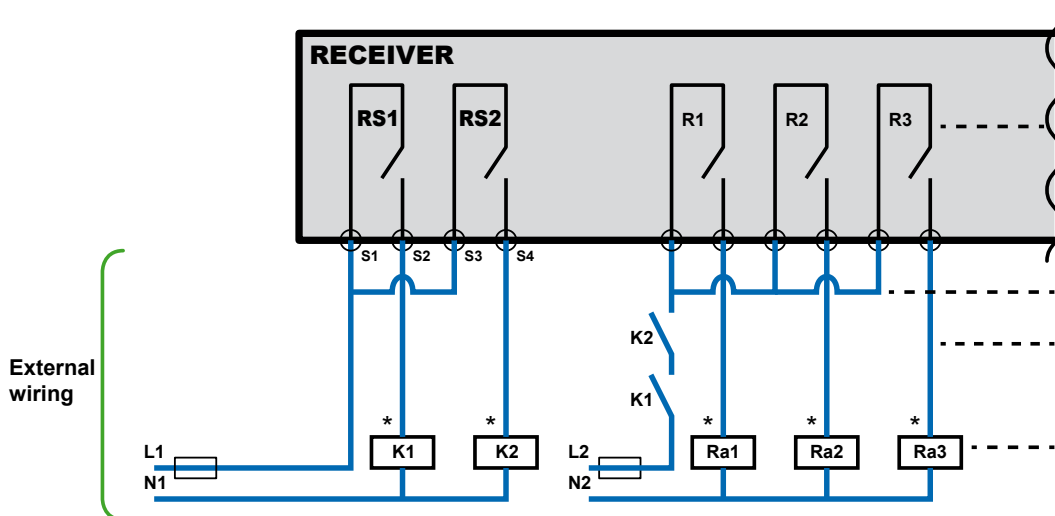

**K1** and **K2** are guided contact contactors, to be integrated in the safety circuit of the system controlled.

The 2 safety relays **RS1** and **RS2** are activated when radio communication is set up between the transmitter and the receiver, and are automatically maintained up to the moment of active or passive shutdown (action on stop palm-switch button, loss of radio link, battery discharged, "Standby mode" function activated ...).

\* = The use of overvoltage limiting circuits will increase the service life of the relay contacts (ex: RC circuits with AC, diodes + Zener with DC, etc...).

### 6.7.7 Interference suppression of the installation and protection of relay outputs

In the event of inductive loads on the Transceiver relay outputs (contactor coils, solenoid valves or electro-brakes), interference suppression devices such as capacitors, RC circuits, diodes, etc. must be placed directly at the terminals of the controlled components using the shortest possible connections.

A pull-up resistor should also be used on the PLC controller inputs..

Examples of protection system to be used :

Receiver Relay Output Terminal Block

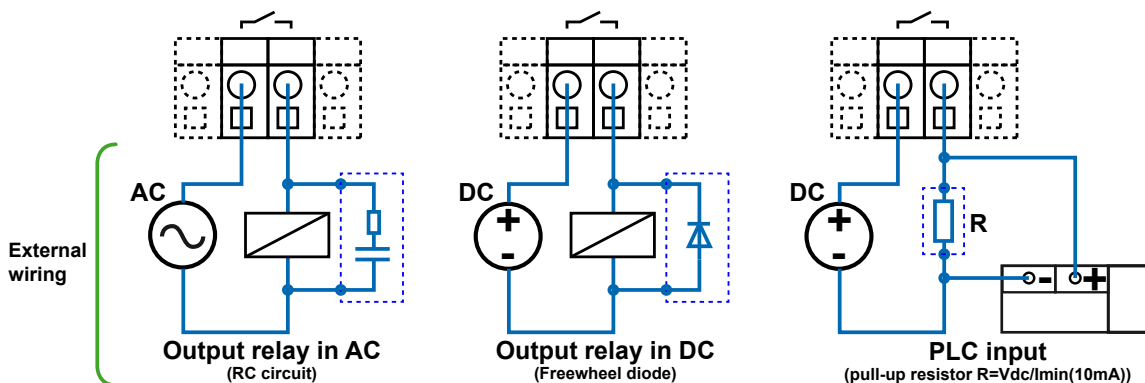

### 6.7.8 Protection of the power supply

Protection against overcurrents (EN60204-1 §7.2) resulting from overvoltages.

A fuse or other protection device should be provided in the power supply circuit of the receiver (see wiring diagram for standard assemblies, item F• next pages) The assigned current is defined in chapter «**Technical data**», page 59.

# (6 - Installation)

## 6.8 Wiring diagrams and assignment of buttons/relays for standard assemblies

### 6.8.1 Standard unit using receiver URR

Safety relays **RS1** and **RS2** are switched on by the green pushbutton «On/Horn» of UDE transmitter, and hold in position until the transmitter stop palmswitch button «STOP» is pressed (active shutdown) or until the loss of the radio transmission (passive shutdown).

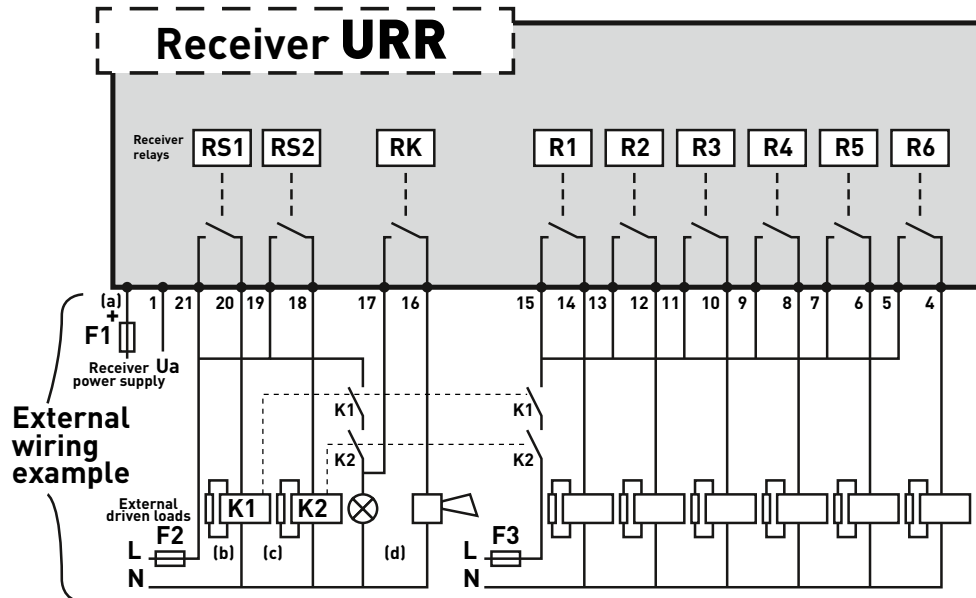

- (a)= The power supply connection depends on the type of receiver and the power supply required:  
terminals 2 - 1 for power supplies 24 VDC, 24 VAC or 115 VAC  
terminals 3 - 1 for power supplies 12 VDC, 48 VAC or 230 VAC.
- (b)= Relay life is increased by the use of surge limiters (ex.RC network for AC, Zener + diodes for DC, etc...)
- (c)= K1 and K2 contactors must have guided contacts
- (d)= Elements which indicate start of remote controlled machines (ex.: horn, rotaring/flashing light, etc...)

### Unit ref: UD1R14...

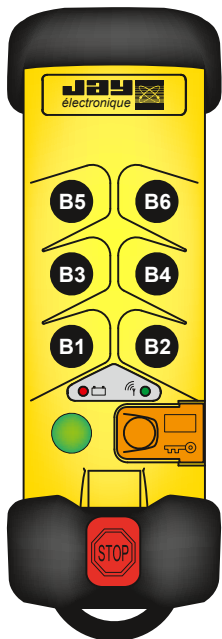

Transmitter with 6 one-step pushbuttons

		ACTIVATED relay of the receiver URR						
		RK	R1	R2	R3	R4	R5	R6
OPERATED button of the transmitter UDE	Green button «On/Horn»	X						
	B1		X					
	B2			X				
	B3				X			
	B4					X		
	B5						X	
	B6							X

# (6 - Installation)

## 6.8.2 Standard units using receiver UCR

Safety relays **RS1** and **RS2** are switched on by the green pushbutton «On/Horn» of UDE transmitter, and hold in position until the transmitter stop palmswitch button «STOP» is pressed (active shutdown) or until the loss of the radio transmission (passive shutdown).

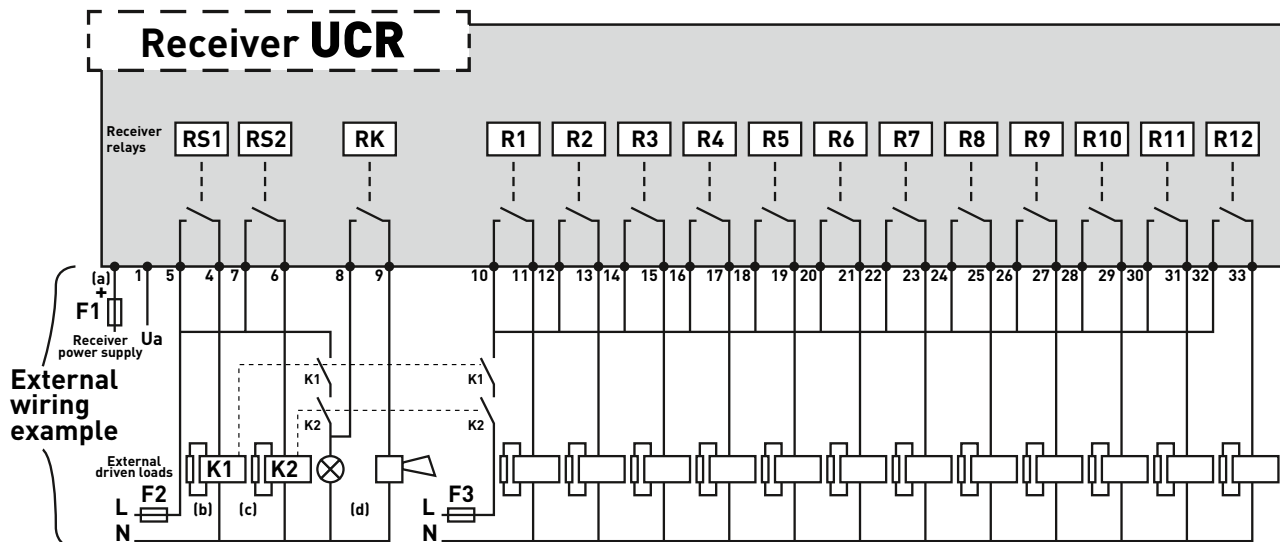

- (a)= The power supply connection depends on the type of receiver and the power supply required:  
 terminals 2 - 1 for power supplies 48 VAC or 12 VDC  
 terminals 3 - 1 for power supplies 230 VAC or 24 VDC
- (b)= Relay life is increased by the use of surge limiters (ex.RC network for AC, Zener + diodes for DC, etc...)
- (c)= K1 and K2 contactors must have guided contacts
- (d)= Elements which indicate start of remote controlled machines (ex.: horn, rotaring/flashing light, etc...)

### Unit ref: UD2C140C•

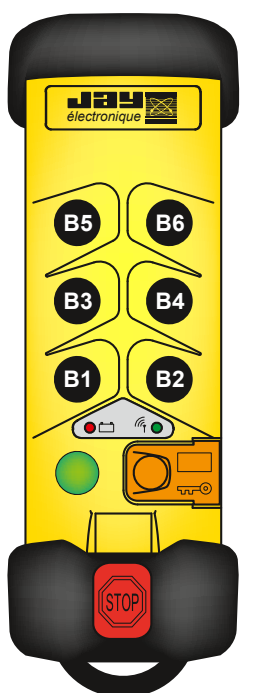

Transmitter with 6 two-step pushbuttons

		ACTIVATED relay of the receiver UCR (With dedicated second speed relay)														
		RK	R1	R2	R3	R4	R5	R6	R7	R8	R9	R10	R11	R12		
OPERATED button of the transmitter UDE	Green button «On/Horn»	X														
	B1	1st step		X												
		2nd step		X	X											
	B2	1st step				X										
		2nd step				X	X									
	B3	1st step					X									
		2nd step					X	X								
	B4	1st step							X							
		2nd step							X	X						
	B5	1st step										X				
		2nd step										X	X			
	B6	1st step												X		
2nd step													X	X		



# (6 - Installation)

## Units ref: **UD2C240••** and **UD3C240••**

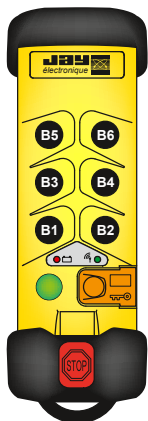

**UD2C240••**  
Transmitter with 6 two-step pushbuttons

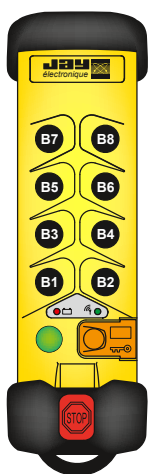

**UD3C240••**  
Transmitter with 8 two-step pushbuttons

		ACTIVATED relay of the receiver UCR (With common second speed relay)													
		RK	R1	R2	R3	R4	R5	R6	R7	R8	R9	R10	R11	R12	
OPERATED button of the transmitter UDE	Green button «On/Horn»	X													
	B1	1st step		X											
		2nd step		X		X									
	B2	1st step			X										
		2nd step			X	X									
	B3	1st step				X									
		2nd step				X		X							
	B4	1st step					X								
		2nd step					X	X							
	B5	1st step							X						
		2nd step							X		X				
	B6	1st step								X					
		2nd step								X	X				
	B7	1st step										X			
		2nd step										X		X	
	B8	1st step											X		
2nd step												X	X		

## Unit ref: **UD5C240••**

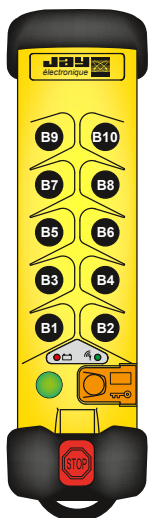

Transmitter with 10 one-step pushbuttons



		ACTIVATED relay of the receiver UCR												
		RK	R1	R2	R3	R4	R5	R6	R7	R8	R9	R10	R11	R12
OPERATED button of the transmitter UDE	Green button «On/Horn»	X												
	B1		X											
	B2			X										
	B3				X									
	B4					X								
	B5						X							
	B6							X						
	B7								X					
	B8									X				
	B9										X			
	B10											X		

# (6 - Installation)

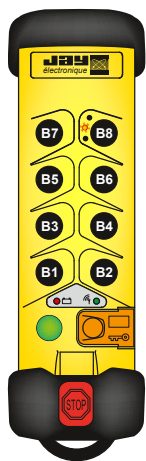
Unit ref: **UD4C240••**



Transmitter with 6 two-step pushbuttons  
+ 1 one-step pushbutton  
+ 1 electronic switch with 3 positions

		ACTIVATED relay of the receiver UCR															
		RK	R1	R2	R3	R4	R5	R6	R7	R8	R9	R10	R11	R12			
<b>OPERATED button of the transmitter UDE</b>	Green button «On/Horn»	X															
	B1	1st step		X													
		2nd step		X		X											
	B2	1st step			X												
		2nd step			X	X											
	B3	1st step					X										
		2nd step					X		X								
	B4	1st step						X									
		2nd step						X	X								
	B5	1st step								X							
		2nd step								X		X					
	B6	1st step									X						
		2nd step									X	X					
	B7												X				
	B8														X		
																X	
														X	X		

# (6 - Installation)

## 6.8.3 Standard units using receiver UDR

Safety relays **RS1** and **RS2** are switched on by the green pushbutton «On/Horn» of UDE transmitter, and hold in position until the transmitter stop palmswitch button «STOP» is pressed (active shutdown) or until the loss of the radio transmission (passive shutdown).

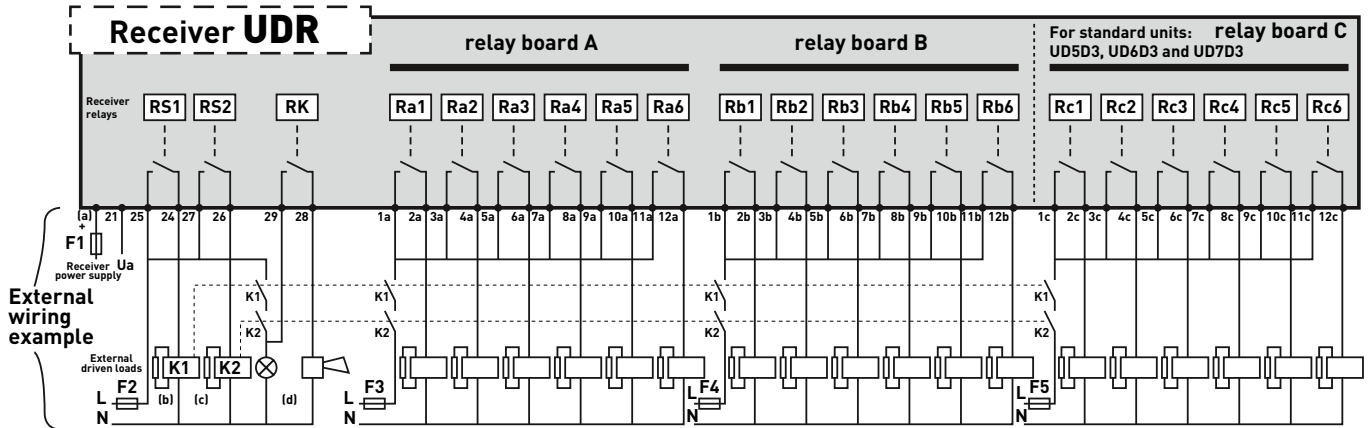

- (a)= The power supply connection depends on the type of receiver and the power supply required:  
 terminals 23 - 21 for power supplies 12 VDC, 24 VAC or 115 VAC  
 terminals 22 - 21 for power supplies 24 VDC, 48 VAC or 230 VAC
- (b)= Relay life is increased by the use of surge limiters (ex.RC network for AC, Zener + diodes for DC, etc...)
- (c)= K1 and K2 contactors must have guided contacts
- (d)= Elements which indicate start of remote controlled machines (ex.: horn, rotating/flashing light, etc...)

### Unit ref: UD4D2....

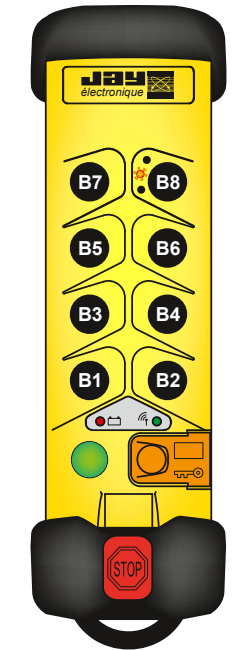

Transmitter with 6 two-step pushbuttons + 1 one-step pushbutton + 1 electronic switch with 3 positions

		ACTIVATED relay of the receiver UDR												
		RK	Ra1	Ra2	Ra3	Ra4	Ra5	Ra6	Rb1	Rb2	Rb3	Rb4	Rb5	Rb6
OPERATED button of the transmitter UDE	Green button «On/Horn»	X												
	B1	1st step		X										
		2nd step		X		X								
	B2	1st step			X									
		2nd step			X	X								
	B3	1st step					X							
		2nd step					X		X					
	B4	1st step						X						
		2nd step						X	X					
	B5	1st step								X				
		2nd step								X		X		
	B6	1st step									X			
2nd step										X	X			
B7	1st step											X		
	2nd step												X	
B8	1st step												X	
	2nd step												X	
	3rd step											X	X	

# (6 - Installation)

Units ref: **UD2D2.....**, **UD3D2.....** and **UD6D3.....**

		ACTIVATED relay of the receiver UDR (With common second speed relay)																			
		RK	Ra1	Ra2	Ra3	Ra4	Ra5	Ra6	Rb1	Rb2	Rb3	Rb4	Rb5	Rb6	Rc1	Rc2	Rc3	Rc4	Rc5	Rc6	
<b>OPERATED button of the transmitter UDE</b>	Green button «On/Horn»	X																			
	B1	1st step		X																	
		2nd step		X		X															
	B2	1st step			X																
		2nd step			X	X															
	B3	1st step				X															
		2nd step				X		X													
	B4	1st step					X														
		2nd step					X	X													
	B5	1st step							X												
		2nd step							X		X										
	B6	1st step								X											
		2nd step								X	X										
	B7	1st step										X									
		2nd step										X		X							
	B8	1st step											X								
		2nd step											X	X							
	B9	1st step													X						
		2nd step													X		X				
	B10	1st step														X					
2nd step															X	X					

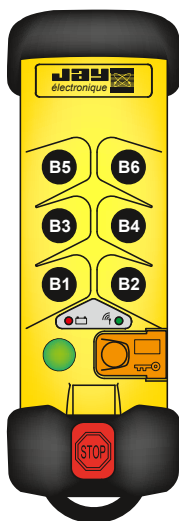

**UD2D2.....**

Transmitter with  
6 two-step pushbuttons  
Receiver with 12 relays

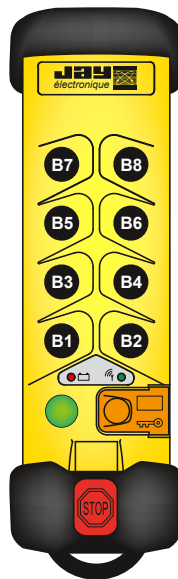

**UD3D2.....**

Transmitter with  
8 two-step pushbuttons  
Receiver with 12 relays

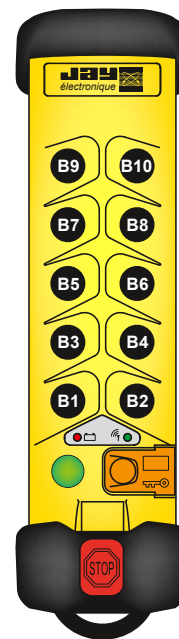

**UD6D3.....**

Transmitter with  
10 two-step pushbuttons  
Receiver with 18 relays

# (6 - Installation)

Units ref: **UD1D29...** and **UD5D3...**

		ACTIVATED relay of the receiver UDR																		
		RK	Ra1	Ra2	Ra3	Ra4	Ra5	Ra6	Rb1	Rb2	Rb3	Rb4	Rb5	Rb6	Rc1	Rc2	Rc3	Rc4	Rc5	Rc6
<b>OPERATED</b> button of the transmitter <b>UDE</b>	Green button «On/Horn»	X																		
	B1		X																	
	B2			X																
	B3				X															
	B4					X														
	B5							X												
	B6								X											
	B7										X									
	B8											X								
	B9													X						
	B10														X					

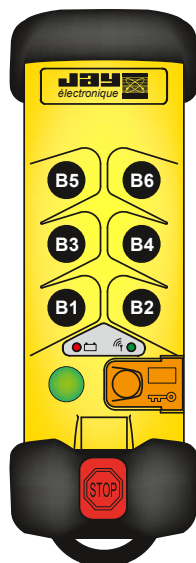

**UD1D29...**

Transmitter with  
6 one-step pushbuttons  
Receiver with 12 relays

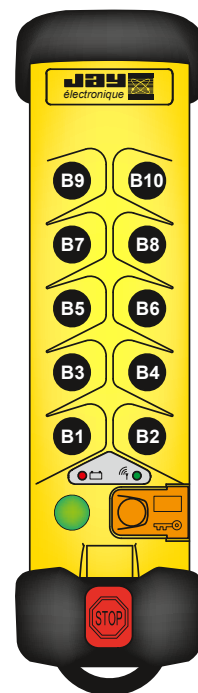







**UD5D3...**

Transmitter with  
10 one-step pushbuttons  
Receiver with 18 relays

# (6 - Installation)

Unit ref: **UD7D3.....**

		ACTIVATED relay of the receiver UDR (With common second speed relay)																			
		RK	Ra1	Ra2	Ra3	Ra4	Ra5	Ra6	Rb1	Rb2	Rb3	Rb4	Rb5	Rb6	Rc1	Rc2	Rc3	Rc4	Rc5	Rc6	
<b>OPERATED</b> button of the transmitter <b>UDE</b>	Green button «On/Horn»	X																			
	B1	1st step		X																	
		2nd step		X		X															
	B2	1st step			X																
		2nd step			X	X															
	B3	1st step				X															
		2nd step				X		X													
	B4	1st step					X														
		2nd step					X	X													
	B5	1st step							X												
		2nd step							X		X										
	B6	1st step								X											
		2nd step								X	X										
	B7											X									
	B8												X								
	B9														X						
																X					
															X	X					
	B10																	X			
																			X		
																X	X				

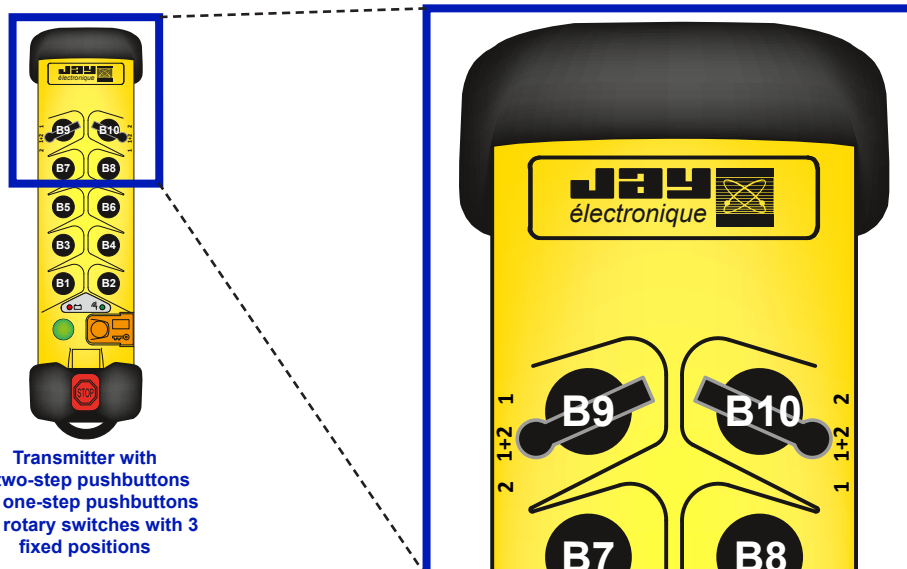

Transmitter with  
6 two-step pushbuttons  
+ 2 one-step pushbuttons  
+ 2 rotary switches with 3  
fixed positions

## (6 - Installation)

### 6.9 Choice of operating radio frequency

To ensure good operating quality, it is important that the radio channel used be free (as well as the preceding and the following one) throughout the area in which the equipment will be controlled.

If several radio remote controls operate on the same site, frequencies should be used at intervals of at least two channels (for example: No.5, No.7, No.9... the more spaced the channels chosen, less there will be the risk of mutual disturbance), and if necessary, a radio frequency plan must be drawn up for identifying the various controlled equipment and their working radio frequency.



The programming of the radio channel is detailed in chapter [«Procedure: programming the radio frequency», page 43](#)

---

#### 6.9.1 Table of possible radio channels following the receiver used

	URR	UCR	UDR
64 frequencies in 433-434MHz bands	YES	YES	YES
12 frequencies in 869MHz band	NO	YES	YES
64 frequencies in 911-918MHz	NO	NO	YES



**See on the following page, all tables of the programmable radio channels according to frequency bands.**

# (6 - Installation)

## 6.9.2 Radio frequency tables

**433-434 MHz bands**

Channel Nb.	Frequency MHz	
01	433,100	
02	433,125	
03	433,150	
04	433,175	
05	433,200	
06	433,225	
07	433,250	
08	433,275	
09	433,300	
10	433,325	
11	433,350	
12	433,375	
13	433,400	
14	433,425	
15	433,450	
16	433,475	
17	433,500	
18	433,525	
19	433,550	
20	433,575	(1)
21	433,600	
22	433,625	(1)
23	433,650	
24	433,675	(1)
25	433,700	
26	433,725	(1)
27	433,750	
28	433,775	(1)
29	433,800	(2)
30	433,825	(1) (2)
31	433,850	(2)
32	433,875	(1) (2)

Channel Nb.	Frequency MHz	
33	433,900	(2)
34	433,925	(1) (2)
35	433,950	(2)
36	433,975	(1) (2)
37	434,000	(2)
38	434,025	(1) (2)
39	434,050	(2)
40	434,075	(2)
41	434,100	(2)
42	434,125	(2)
43	434,150	(2)
44	434,175	(2)
45	434,200	(2)
46	434,225	(2)
47	434,250	(2)
48	434,275	(2)
49	434,300	(2)
50	434,325	(2)
51	434,350	(2)
52	434,375	(2)
53	434,400	(2)
54	434,425	(2)
55	434,450	(2)
56	434,475	(2)
57	434,500	(2)
58	434,525	(2)
59	434,550	(2)
60	434,575	(2)
61	434,600	(2)
62	434,625	(2)
63	434,650	(2)
64	434,675	(2)

**911-918 MHz bands**

Channel Nb.	Frequency MHz	
01	911,800	(3)
02	911,900	(3)
03	912,000	(3)
04	912,100	(3)
05	912,200	(3)
06	912,300	(3)
07	912,400	(3)
08	912,500	(3)
09	912,600	(3)
10	912,700	(3)
11	912,800	(3)
12	912,900	(3)
13	913,000	(3)
14	913,100	(3)
15	913,200	(3)
16	913,300	(3)
17	913,400	(3)
18	913,500	(3)
19	913,600	(3)
20	913,700	(3)
21	913,800	(3)
22	913,900	(3)
23	914,000	(3)
24	914,100	(3)
25	914,300	(3)
26	914,400	(3)
27	914,500	(3)
28	914,600	(3)
29	914,700	(3)
30	914,800	(3)
31	914,900	(3)
32	915,000	(3)

Channel Nb.	Frequency MHz	
33	915,100	(3)
34	915,200	(3)
35	915,300	(3)
36	915,400	(3)
37	915,500	(3)
38	915,600	(3)
39	915,700	(3)
40	915,800	(3)
41	915,900	(3)
42	916,000	(3)
43	916,100	(3)
44	916,200	(3)
45	916,300	(3)
46	916,400	(3)
47	916,500	(3)
48	916,600	(3)
49	916,700	(3)
50	916,800	(3)
51	916,900	(3)
52	917,000	(3)
53	917,100	(3)
54	917,200	(3)
55	917,300	(3)
56	917,400	(3)
57	917,500	(3)
58	917,600	(3)
59	917,700	(3)
60	917,800	(3)
61	917,900	(3)
62	918,000	(3)
63	918,100	(3)
64	918,200	(3)

**869 MHz band**

Channel Nb.	Frequency MHz
01	869,9875
02	869,9625
03	869,9375
04	869,9125
05	869,8875
06	869,8625
07	869,8375
08	869,8125
09	869,7875
10	869,7625
11	869,7375
12	869,7125

(1)= list of available frequencies for Denmark  
 (2)= list of available frequencies for Singapore  
 (3)= list of available frequencies for the U.S.



# 7 - Configuration and Parameterization

The following actions are possible from the housing of the **UDE** transmitter :

- Programming the transmission radio frequency (selecting the radio channel number).
- Programming of the time delay for the «Standby mode» function (01 to 98 minutes and infinite).
- Copy of electronic key identity code to transmitter memory.

These configuration operations use procedures implementing the following buttons **B1**, **B2**, **B3**, **stop palmswitch** and «**On/Horn**» without having to open the transmitter or the receiver.

By a specific programming procedure, the person in charge of the equipment can **lock** or **unlock** the access to the programming of Transmit radio frequency and «Standby mode» function delay by locking or unlocking the electronic key (see «**Procedure: «Locking-unlocking» the electronic key**», page 42).

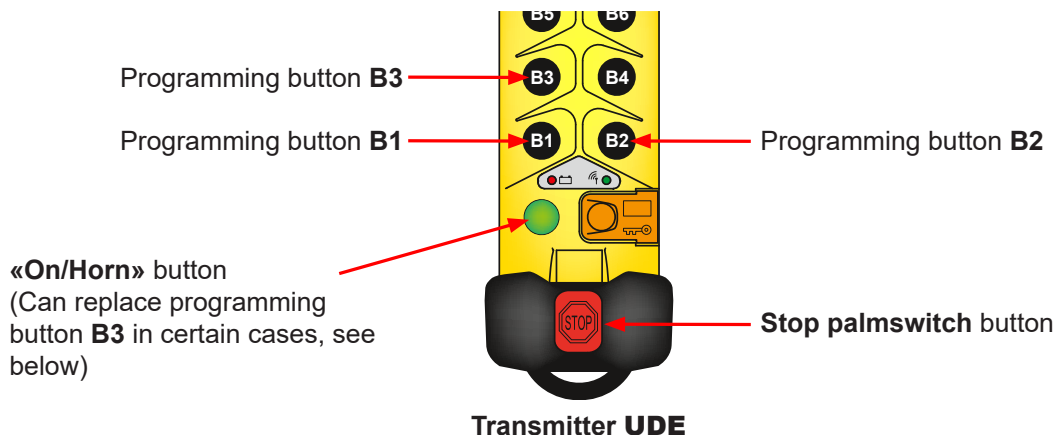

## Programming limitations by the button type implemented at position «button B1», «button B2» and «button B3» on the **UDE** transmitter :

In order for the four programming functions to be programmable (locking-unlocking the electronic key, radio frequency, «Standby mode» delay and identity code copy), button **B1** and button **B2** must be single or double speed pushbutton types (**BPSV** or **BPDV**).

If not, certain functions may not be accessible to the user.

The following table shows the available or unavailable programming modes depending on the type of button in position **B1** and **B2** :

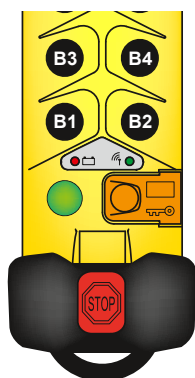

Button B1	Button B2	Locking - unlocking the electronic key	radio frequency programming	«Standby mode» delay programming	Copying electronic key identity code into transmitter
BPSV or BPDV	BPSV or BPDV	YES	YES	YES	YES
BPSV or BPDV	Other *	NO	NO	YES	NO
Any other button configuration *		NO	NO	NO	NO

\* = COM2, COM3, COM3R or BPTR

**IMPORTANT :** If programming button n°3 is not of **BPSV** or **BPDV** type, the green «**On/Horn**» button takes then the role of programming button, and substitutes itself for button **B3**.



Configuration parameters which cannot be programmed by the user will be taken into account when ordering, but will not be re-configurable once the transmitter is manufactured.

However, it is always possible to order an electronic key containing the desired parameters (ref.: **UDWE23**).

## (7 - Configuration and Parameterization)

### 7.1 Procedure: «Locking-unlocking» the electronic key

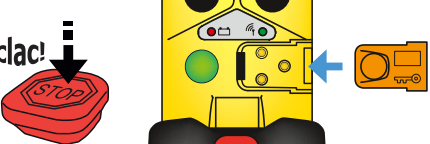
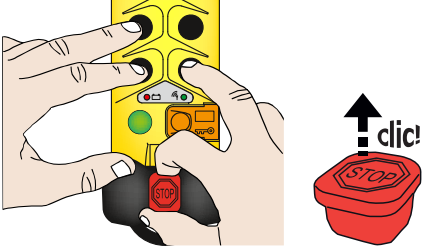
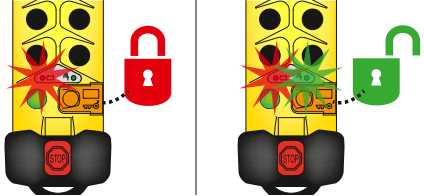
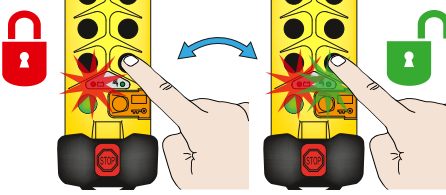
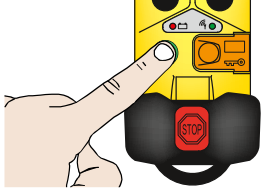
The transmit radio frequency and the «Standby mode» function delay are saved into the electronic key memory. Procedure below enables authorization (electronic key unlocked) or prohibition (electronic key locked) of any modification of these 2 parameters.

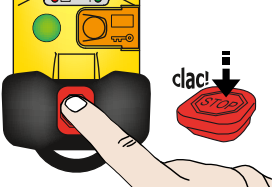
1	Switch OFF the receiver.	
2	Press the transmitter <b>stop palmswitch button</b> and insert the electronic key into the transmitter housing.	
3	While holding buttons <b>B1</b> , <b>B2</b> and <b>B3</b> * pressed, unlock the <b>stop palmswitch button</b> .	
4	Release the buttons. Indicator light statuses: : <ul style="list-style-type: none"> <li>■ <b>Electronic key locked</b> : red indicator light on, green indicator light off.</li> <li>■ <b>Electronic key unlocked</b> : red and green indicator lights on.</li> </ul>	
5	Select «locked» or «unlocked» by pressing button <b>B2</b> : the selected mode is shown by the indicator lights.	
6	Validate the selected mode by pressing the green «On/Horn» button.	
7	The information «locked electronic key» or «unlocked electronic key» is stored in the electronic key, the indicator lights turn off.	
8	Exit the configuration mode by pressing the <b>stop palmswitch button</b> .	

\* = If the button **B3** is not **BPSV** or **BPDV** type, use then the green «On/Horn» button.

**Remark:** if an operator attempts to program the radio frequency or the «Standby mode» function time delay when the electronic key is locked, the transmitter will indicate an «**electronic key locked**» error (alternating flashes of its 2 indicator lights).

# (7 - Configuration and Parameterization)

## 7.2 Procedure: programming the radio frequency

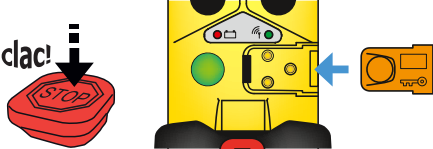
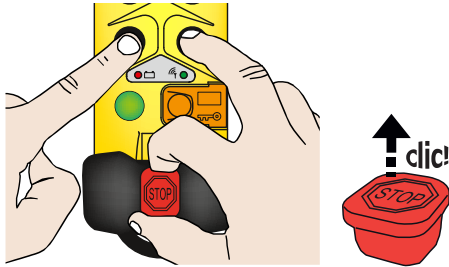
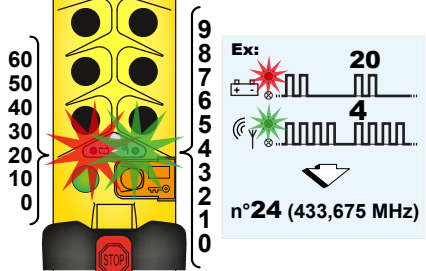
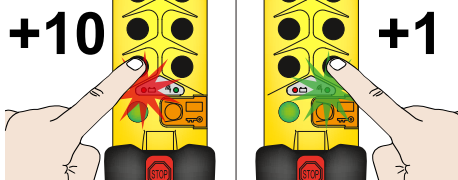
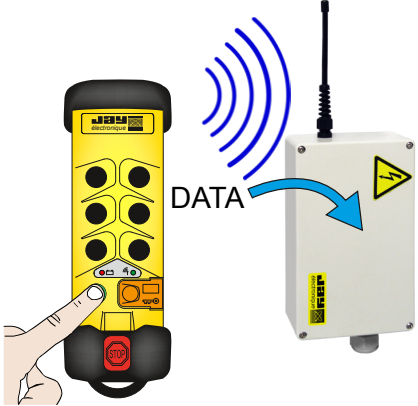
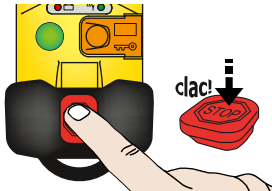

See the radio frequency tables in the chapter [«Installation», page 21](#) to select a radio channel number from those proposed in the frequency band used by the radio control.

<p><b>1</b></p>	<p>Switch ON the receiver.</p>	
<p><b>2</b></p>	<p>Press the transmitter <b>stop palmswitch button</b> and insert the electronic key into the transmitter housing.</p>	
<p><b>3</b></p>	<p>While holding buttons <b>B1</b> and <b>B2</b> pressed, unlock the <b>stop palmswitch button</b>.. If transmitter red and green indicator lights flash in alternation :</p> <p>The electronic key <b>is locked</b>. Press the stop palmswitch button and follow procedure described on chapter <a href="#">«Procedure: «Locking-unlocking» the electronic key», page 42</a> to unlock the electronic key. Then repeat this procedure from point 3.</p>	
<p><b>4</b></p>	<p>The display of the current radio channel number is done by the flashing of the transmitter indicator lights: <b>the red light</b> represents the tens (0, 10, 20.....60) and <b>the green light</b> represents the units (0, 1, 2, 3.....9)</p> <p><b>Example</b> : The red light flashes 2 times and green light flashes 4 times = the radio channel number is No.24 (frequency: 433,675MHz on 433-434MHz bands)</p>	
<p><b>5</b></p>	<p>Select the new radio channel using buttons <b>B1</b> and <b>B2</b>. Press button <b>B1</b> to increment the tens and button <b>B2</b> to increment the units. During these operations, the newly selected channel is displayed by the 2 indicator lights on the transmitter which flash accordingly.</p>	
<p><b>6</b></p>	<p>Once the desired channel is selected (between 01 and 64 for 433-434MHz/911-918MHz bands or 01 to 12 for 869MHz band), press the green <b>«On/Horn»</b> button to validate the selection.</p> <ul style="list-style-type: none"> <li>■ <b>Briefly pressing «On/Horn» button</b> : the transmitter sends the selected radio channel number to the receiver and saves its new working radio channel.</li> <li>■ <b>By pressing and holding the «On/Horn» button (3 seconds approx)</b> : the transmitter sends the selected channel number to the receiver (on each of the radio link channels between 01 to 64 for 433-434MHz/911-918MHz bands or 01 to 12 for 869MHz band) and saves its new working channel. Wait until the transmitter indicator lights no longer flash (around 30 seconds) (<i>this longer procedure is preferable and should be performed when you are not familiar with the initial working channel of the receiver</i>).</li> </ul>	
<p><b>7</b></p>	<p>Exit the configuration mode by pressing the <b>stop palmswitch button</b>.</p>	
<p><b>8</b></p>	<p>Check that the receiver has changed the radio channel by performing the startup procedure</p>	

## (7 - Configuration and Parameterization)

### 7.3 Procedure: time delay for the «Standby mode» function

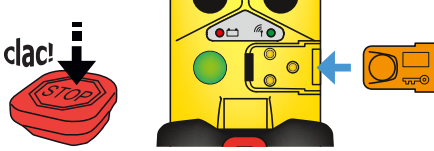
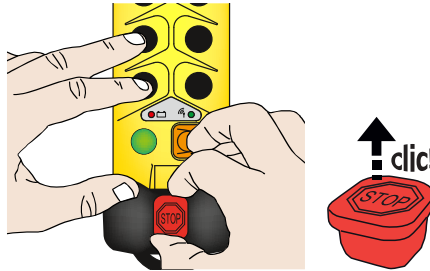
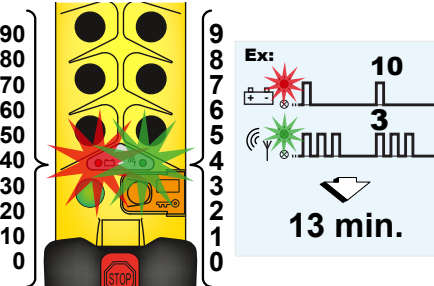
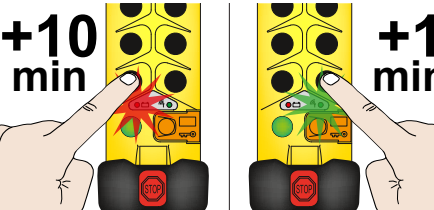
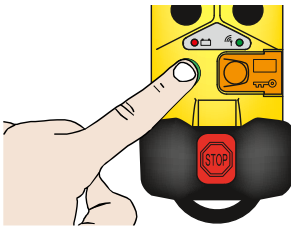
The «Standby mode» function is described in chapter «[«Standby mode» function](#)».

<p><b>1</b></p>	<p>Switch OFF the receiver.</p>	
<p><b>2</b></p>	<p>Press the transmitter <b>stop palmswitch button</b> and insert the electronic key into the transmitter housing.</p>	
<p><b>3</b></p>	<p>While holding buttons <b>B1</b> and <b>B3</b> * pressed, unlock the <b>stop palmswitch button</b>. If transmitter red and green indicator lights flash in alternation :</p> <p>The electronic key is <b>locked</b>. Press the stop palmswitch button and follow procedure described on chapter «<a href="#">Procedure: «Locking-unlocking» the electronic key</a>», page 42 to unlock the electronic key. Then repeat this procedure from point 3.</p>	
<p><b>4</b></p>	<p>The display of the current time delay is done by the flashing of the transmitter indicator lights: <b>the red indicator light</b> represents the tens (0, 10, 20.....90) and <b>the green indicator light</b> represents the minutes (0, 1, 2, 3.....9) <b>Example</b> : the red indicator light flashes 1 time and the green indicator light flashes 3 times: the time delay is 13mn before the system comes to «Standby mode».</p>	
<p><b>5</b></p>	<p>Select the new time delay using buttons <b>B1</b> and <b>B2</b>. Press button <b>B1</b> to increment by ten minutes and button <b>B2</b> to increment by one minute. During these operations, the new time selected is displayed by the two indicator lights on the transmitter.</p>	
<p><b>6</b></p>	<p>Once the desired «dead man» time have been selected (between 01 and 99), press the green «On/Horn» button to validate the selection. <b>Attention</b> : 99 minutes duration corresponds to an <u>infinite</u> time delay for the «Standby mode» function. This function is then deactivated, if the user forgets to stop the transmitter (by pressing the stop palmswitch button), it remains in radio transmission until the battery is completely discharged.</p>	
<p><b>7</b></p>	<p>The information «time delay for Standby mode function» is stored in the electronic key, the indicator lights turn off.</p>	
<p><b>8</b></p>	<p>Exit the configuration mode by pressing the <b>stop palmswitch button</b>.</p>	

\* = If the button **B3** is not **BPSV** or **BPDV** type, use then the green «On/Horn» button.

## (7 - Configuration and Parameterization)

### 7.4 Procedure: Recopying the electronic key identity code

Apply this procedure when :

- starting the radio remote control for the first time
- using a maintenance/backup transmitter
- changing the electronic key

**Reminder:** To use the UD radio remote control system, the identity code contained in the transmitter memory must match the identity code in the electronic key which is itself identical to that of the receiver.

If a maintenance/backup transmitter is used or if the electronic key has been changed, the information contained in the electronic key must be copied in the **UDE** transmitter memory (see chapter «[Electronic key](#)», page 14)

**Conditions for using this procedure :**

The configuration of the backup transmitter buttons must be identical to that described in the electronic key (or the original transmitter).

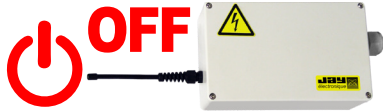
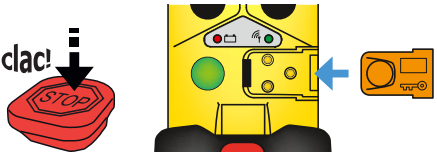
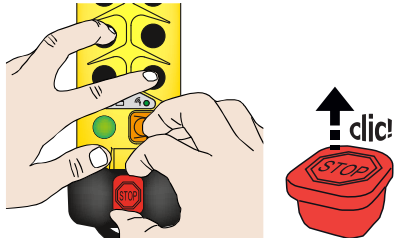
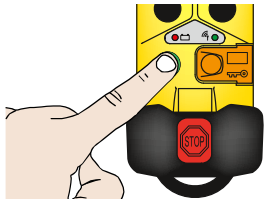
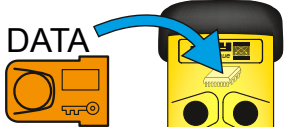
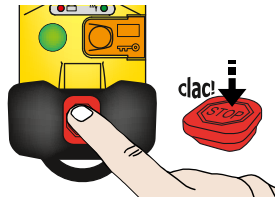
<b>1</b>	Switch OFF the receiver.	
<b>2</b>	Press the transmitter <b>stop palmswitch button</b> and insert the electronic key into the transmitter housing.	
<b>3</b>	While holding buttons <b>B2</b> and <b>B3</b> * pressed, unlock the <b>stop palmswitch button</b> : the 2 indicator lights on the transmitter will flash rapidly	
<b>4</b>	Press the green « <b>On/Horn</b> » button to perform automatic programming of the identity code: the two indicator lights on the transmitter go off	
<b>5</b>	The «identity code» information is copied from the electronic key to the transmitter memory.	
<b>6</b>	Exit the configuration mode by pressing the <b>stop palmswitch button</b> .	

\* = If the button **B3** is not **BPSV** or **BPDV** type, use then the green «**On/Horn**» button.

# (7 - Configuration and Parameterization)

## 7.5 Receiver configuration

The following parameters can be configured on the receiver :

### ■ Interlocking controls :

Factory configured or using a PC via serial link option ref.: **UDWR32** and programming software **DialogUD** ref.:**UDWR37**.

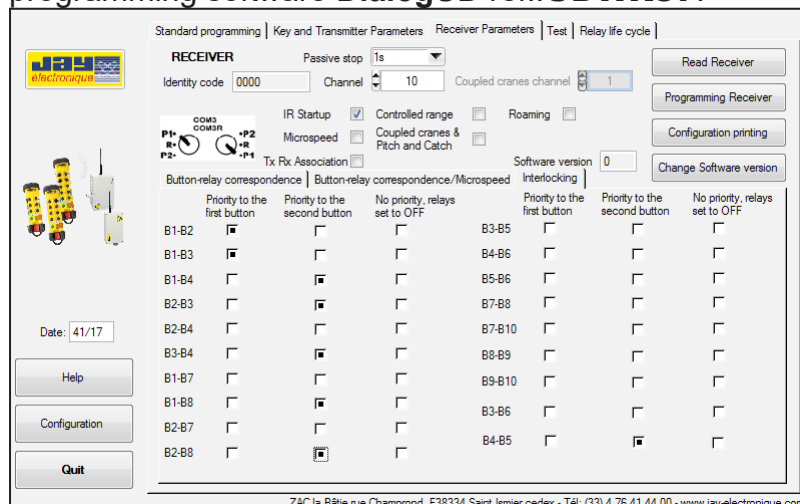

### ■ Transmitter buttons / receiver function relays correspondence :

Factory configured or using a PC via serial link option ref.: **UDWR32** and programming software **DialogUD** ref.:**UDWR37**.

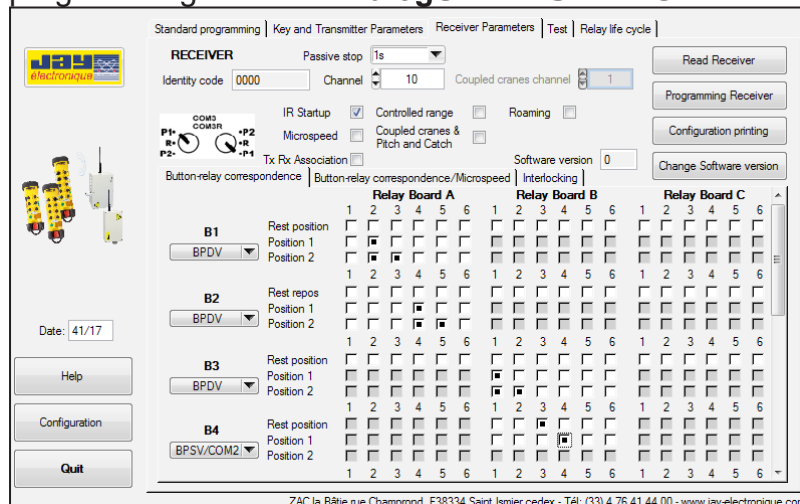

### ■ The receiving radio frequency :

The radio reception frequency (channel No.) can be programmed in two ways :

- ◇ By the transmitter matched to the receiver implementing the transmitter frequency programming procedure, see chapter [«Procedure: programming the radio frequency», page 43](#).
- ◇ By using a PC via serial link option ref.: **UDWR32** and programming software **DialogUD** ref.:**UDWR37**.

## 8 - Commissioning and use

### 8.1 Precautions to be observed before commissioning

- Check that the electronic key matches the radio receiver (the identity code written on the identification label of the electronic key must be identical to the identity code written on the receiver's label).
- Check that the selected radio channel number matches the frequency plan established on the site.
- Perform a final check to verify that the desired Button-Relay correspondence is in place. During the previous check, the installer must check that when the green «On/Horn» button is pressed on startup, only the safety relays and function relays assigned to rotary switch selections are activated.
- Verify the priority general shutdown mode (remote control in operation and radio link established) :
  - ◇ **Active stop** : Pressing the transmitter's stop plamswitch button instantaneously deactivates the receiver safety relays (**RS1** and **RS2**).
  - ◇ **Passive stop** : Remove the electronic key (or battery) from the transmitter, the safety relays (**RS1** and **RS2**) on the receiver must be deactivated within 2 seconds.
- **Time delay for «Standby mode» function :**

Check the effective time delay of the «Standby mode» function (time delay before automatic shutdown of transmitter) :

Start up the remote control and leave it without activating any control. Note the time after which the safety relays (**RS1** and **RS2**) of the receiver are deactivated and check whether this duration corresponds to that delivered in standard (4mn) or to the duration after a change by a trained and authorized operator (by following the procedure described in paragraph **««Standby mode» function», page 55.**).
- **Radio range limits and infrared range limit if the system is equipped with an IR option :**

Evaluate the range limit of the transmitter/receiver assembly (by moving up to the range limit).

Make sure of the good infrared area covering by the IR module(s).

## (8 - Commissioning and use)

### 8.2 Starting the radio control

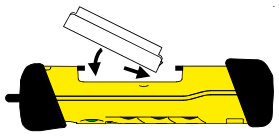
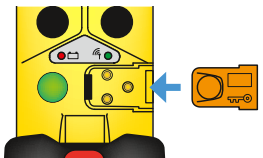
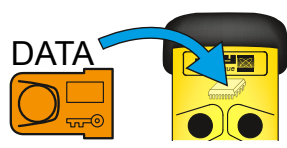
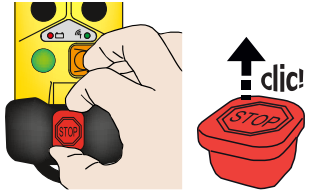
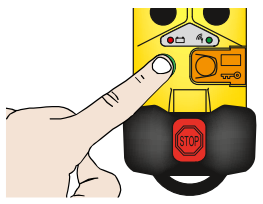
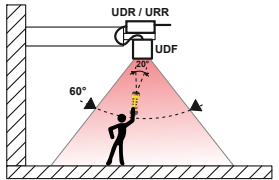
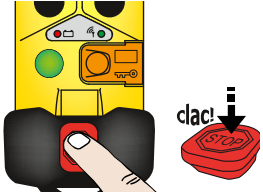
<b>1</b>	Switch ON the receiver.	
<b>2</b>	Take care that <b>UDB2</b> or <b>UWB</b> battery is charged and is well connected to transmitter back.	
<b>3a</b>	Insert the electronic key into the transmitter housing.	
<b>3b</b>	<p><b>This step is to be followed only during the <u>first start</u> of the radio control :</b></p> <p>The information contained in the electronic key supplied with your remote control must be «copied» into the internal memory of the radio transmitter.</p> <p>For this, please follow the procedure described in the chapter <a href="#">«Procedure : Recopying the electronic key identity code»</a>, page 45</p>	
<b>4</b>	Unlock the transmitter <b>stop</b> palmswitch button.	
<b>5</b>	<p>Press the green «On / Horn» button on the transmitter until the receiver is activated (activation of the <b>RS1</b> and <b>RS2</b> safety relays).</p> <div style="border: 2px solid red; padding: 5px; margin: 10px 0;"> <p><b>If the UD system is equipped with the «start with infrared validation» or «Transmitter/Receiver association on start-up» option:</b></p> <p>with the transmitter, aim for the <b>UDF</b> infrared module (s) delimiting the start zone while pressing the green «On / Horn» button.</p> </div>	 
<b>6</b>	Use the radio remote control to control the equipment.	
<b>7</b>	<p><b>To stop the radio control:</b></p> <p>Press the transmitter stop palmswitch button.</p> <p>The safety relays as well as the function relays of the receiver are deactivated.</p>	



If this procedure is not followed, the transmitter reports an error with its green and red indicator lights:

- «**3 flashes**» error type (the green and red indicator lights of the transmitter flash 3 times, pause, then flash 3 times, etc...) : repeat the **identity code copying procedure** described in the chapter [«Procedure : Recopying the electronic key identity code»](#), page 45.
- «**5 flashes**» error type (the green and red indicator lights of the transmitter flash 5 times, pause, then flash 5 times, etc...) : **stop or start error** (make sure that the battery is correctly inserted in the transmitter housing and resume the radio remote control startup procedure).



# (8 - Commissioning and use)

## 8.3 Operating chronogram

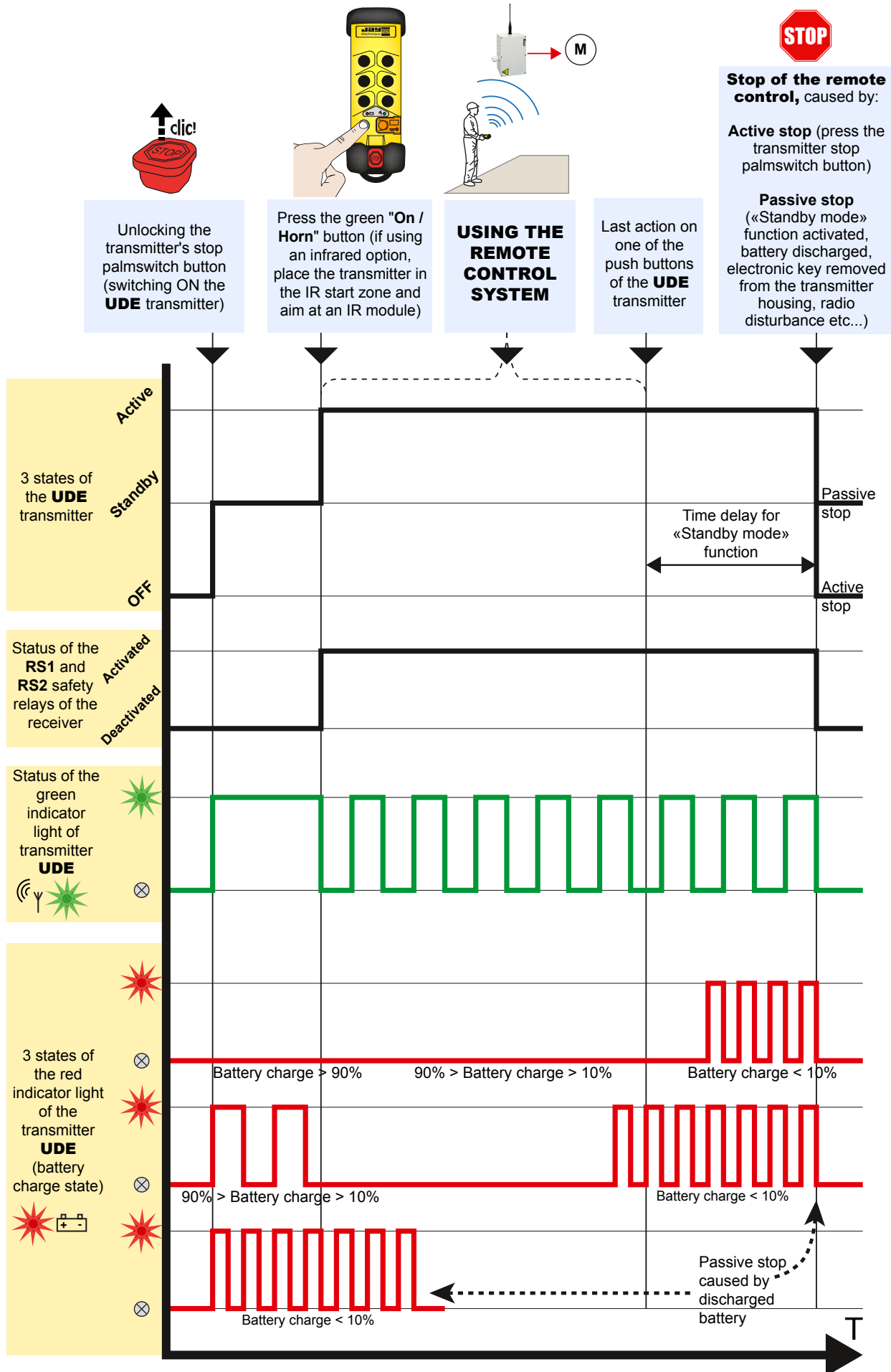

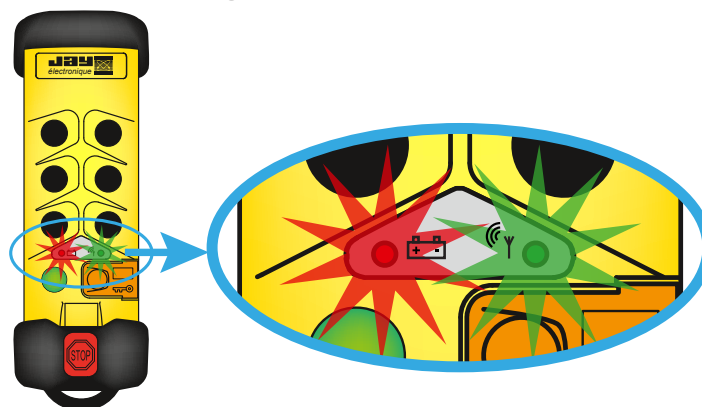

## (8 - Commissioning and use)

### 8.4 Transmitter UDE indicator lights functions





#### Error messages

Transmitter state (The transmitter stop palmswitch is unlocked)	RED indicator light 	GREEN indicator light 	Possible causes of failure	Possible remedies
Before or after «On/horn» button is pressed	<b>continuously OFF</b>		<ul style="list-style-type: none"> <li>- Battery is discharged or disconnected</li> <li>- Internal electronic failure</li> </ul>	<ul style="list-style-type: none"> <li>- Check battery charge or</li> <li>- Contact the technical manager</li> </ul>
Before or after «On/horn» button is pressed	<b>continuously ON</b>		<ul style="list-style-type: none"> <li>- Electronic key is not connected to transmitter</li> <li>- Bad connection of the electronic key</li> <li>- Electronic key failure</li> <li>- Internal electronic failure</li> </ul>	<ul style="list-style-type: none"> <li>- Install electronic key on transmitter before powering up the transmitter or</li> <li>- Contact the technical manager</li> </ul>
Before or after «On/horn» button is pressed	<b>flash in a alternative way</b>		<ul style="list-style-type: none"> <li>- Access to the transmitter programming is prohibited (the electronic key is locked)</li> </ul>	<ul style="list-style-type: none"> <li>- If the radio frequency or «Standby mode» function time delay must be changed, the electronic key must be unlocked. Follow procedure described in <a href="#">«Configuration and Parameterization»</a> or</li> <li>- Contact the technical manager</li> </ul>
Before or after «On/horn» button is pressed	<b>2 flashes</b>		<ul style="list-style-type: none"> <li>- Electronic key contact fault</li> </ul>	<ul style="list-style-type: none"> <li>- Check the correct insertion of the electronic key into the transmitter housing or</li> <li>- Contact the technical manager</li> </ul>
Before «On/horn» button is pressed	<b>3 flashes</b>		<ul style="list-style-type: none"> <li>- The transmitter identity code is different from that contained in the electronic key</li> <li>- Internal electronic failure</li> </ul>	<ul style="list-style-type: none"> <li>- Apply the programming procedure: copy the identity code described in the chapter <a href="#">«Configuration and Parameterization»</a> or</li> <li>- Contact the technical manager</li> </ul>
Before or after «On/horn» button is pressed	<b>4 flashes</b>		<ul style="list-style-type: none"> <li>- The button configuration is different from that contained in the electronic and the physical configuration on the transmitter</li> <li>- One or several function buttons are defective</li> <li>- Internal electronic failure</li> </ul>	<ul style="list-style-type: none"> <li>- Contact the technical manager</li> </ul>
Before «On/horn» button is pressed	<b>5 flashes</b>		<ul style="list-style-type: none"> <li>- Micro power cuts due to a bad battery pack connection</li> <li>- Internal electronic failure</li> </ul>	<ul style="list-style-type: none"> <li>- Check that battery pack is correctly inserted in transmitter housing or</li> <li>- Contact the technical manager</li> </ul>
Before «On/horn» button is pressed	<b>6 flashes</b>		<ul style="list-style-type: none"> <li>- Internal electronic failure</li> </ul>	<ul style="list-style-type: none"> <li>- Contact the technical manager</li> </ul>
Before «On/horn» button is pressed	<b>7 flashes</b>		<ul style="list-style-type: none"> <li>- Internal electronic failure</li> </ul>	<ul style="list-style-type: none"> <li>- Contact the technical manager</li> </ul>
Before «On/horn» button is pressed	<b>8 flashes</b>		<ul style="list-style-type: none"> <li>- Internal electronic failure</li> </ul>	<ul style="list-style-type: none"> <li>- Contact the technical manager</li> </ul>

## (8 - Commissioning and use)

### State of the battery charge level

Transmitter state (The transmitter stop palmswitch is unlocked)	RED indicator light 	GREEN indicator light 	Corresponding function or message
Before «On/horn» button is pressed	<b>OFF</b>	<b>continuously ON</b>	Battery charge level > 90%
Before «On/horn» button is pressed	<b>Slow flashing</b>	<b>continuously ON</b>	90% > Battery charge level > LOW BATT* level
Before «On/horn» button is pressed	<b>fast flashing</b>	<b>continuously ON</b>	Battery charge level < or = LOW BATT* level
After «On/horn» button is pressed	<b>OFF</b>	<b>Flashes</b>	<b>Radio transmission</b> Battery charge level > 10%
After «On/horn» button is pressed	<b>fast flashing</b>	<b>Flashes</b>	<b>Radio transmission</b> Battery charge level < or = LOW BATT* level

\* «LOW BATT level» = low battery (battery charge level lower than 10%), the battery must be recharged.

## (8 - Commissioning and use)

### 8.5 Receiver URR, UCR and UDR indicator lights functions

#### Receiver URR

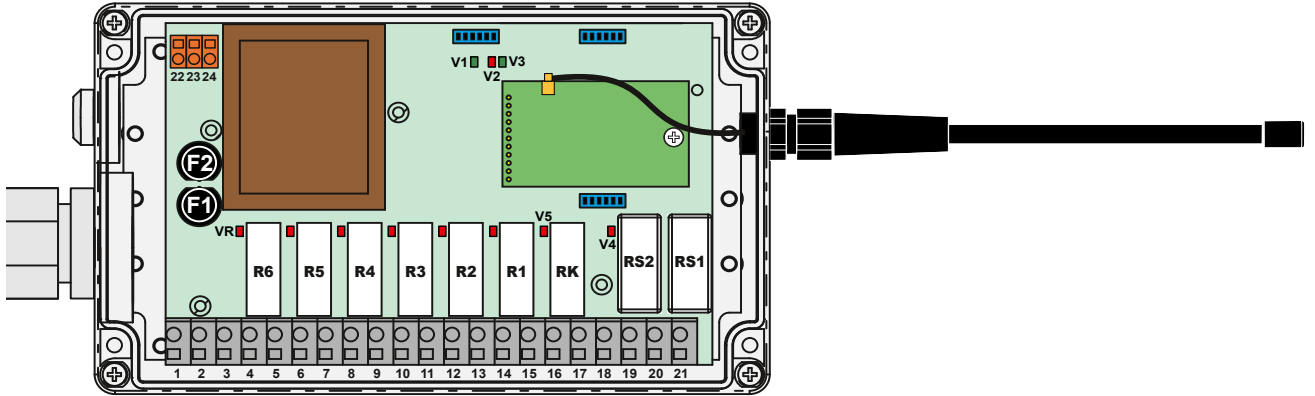

#### Receiver UCR

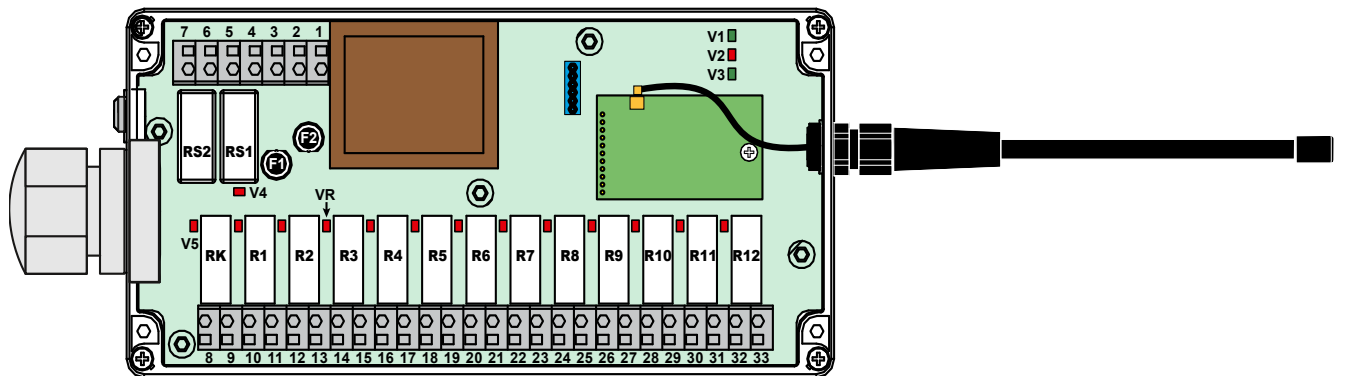

#### Receiver UDR

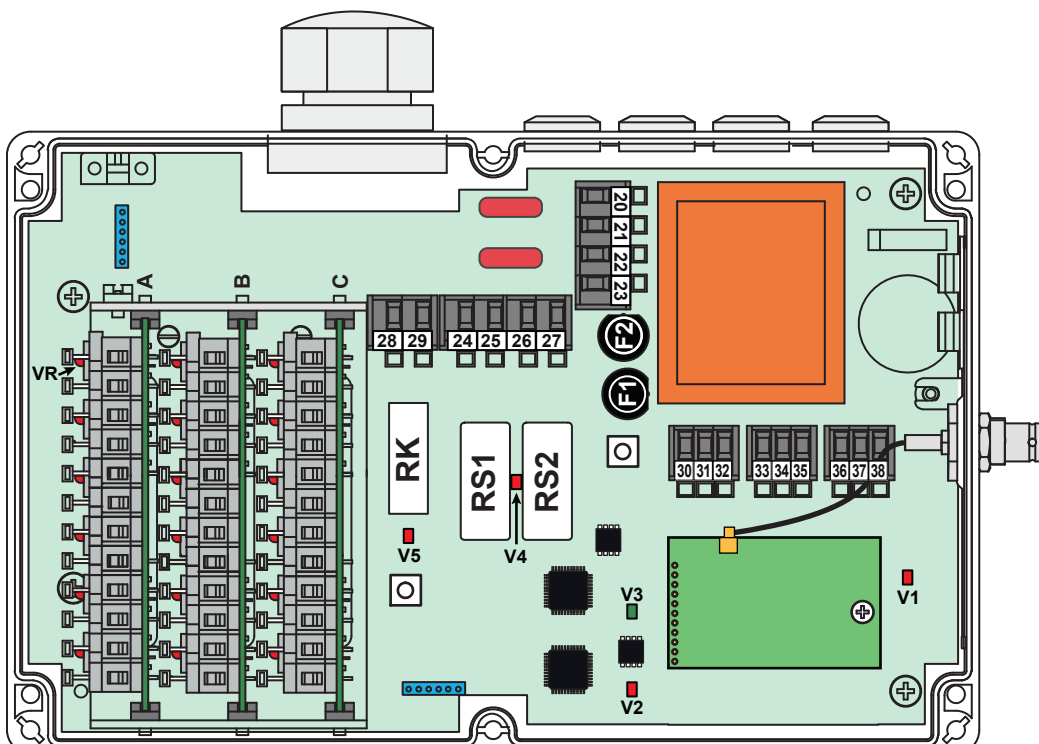

## (8 - Commissioning and use)

Indicator light name and color	Mode	Indication	State	Message
<b>V1</b> Power supply <b>GREEN</b> (except for <b>UDR</b> : <b>RED</b> )	All	Receiver power supply	<b>ON</b>	The receiver is powered
			<b>OFF</b>	The receiver is not powered
<b>V2</b> Microprocessor No.1 <b>RED</b>	Normal	Indicates validity of identity code	<b>OFF</b>	No message reception
			<b>OFF</b>	Message reception with correct identity code
			<b>Regular flashes</b>	Message reception with wrong identity code
	Serial link	RS232 Mode	<b>ON</b>	The receiver programming is in progress
<b>V3</b> Microprocessor No.2 <b>GREEN</b>	Normal	Indicates radio reception quality	<b>OFF</b>	No radio message reception
			<b>flashes</b>	Poor radio reception quality
			<b>ON</b>	Good radio reception quality
	Serial link	RS232 Mode	<b>OFF</b>	nothing to report
<b>V4</b> RS1 and RS2 safety relays <b>RED</b>	All	State of the safety relays	<b>ON</b>	Relays activated (contacts are closed)
			<b>OFF</b>	Relays deactivated (contacts are open)
<b>V5</b> «Horn» RK relay <b>RED</b>	All	State of the «Horn» RK relay	<b>ON</b>	Relay activated (closed contact)
			<b>OFF</b>	Relay deactivated (open contact)
<b>VR</b> function relays R1 to R6/R12/ R18 depending of receiver model <b>RED</b>	All	Indicates each function relays state	<b>ON</b>	Relay activated (closed contact)
			<b>OFF</b>	Relay deactivated (open contact)

### Error messages

Indicator light <b>V2</b> Microprocessor No.1 <b>RED</b>	Indicator light <b>V3</b> Microprocessor No.2 <b>GREEN</b>	Possible causes of failure	Possible remedies
<b>OFF</b> (Mainboard power supplied but power supply red indicator light V1 remains OFF)		- Melted fuses - Wrong power supply wiring - Internal electronic failure	- Check fuse state and calibre - Check power supply wiring diagram according to receiver model or - Contact the technical manager
<b>2 flashes</b> <b>3 flashes</b> <b>4 flashes</b> <b>5 flashes</b> <b>6 flashes</b> <b>7 flashes</b>		- Internal electronic failure	- Contact the technical manager

## 8.6 Infrared module UDF indicator light

For «Startup with IR validation» option or «Transmitter/Receiver association on start-up» option, see chapter «Options», page 56

### Infrared module UDF

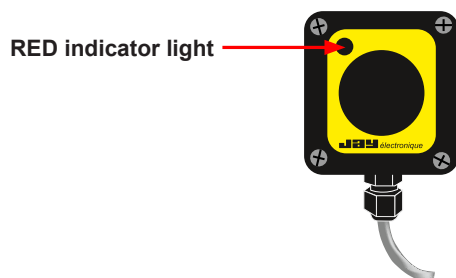

State of the indicator light <b>RED</b>	Description	Possible remedies
<b>OFF</b>	<ul style="list-style-type: none"> <li>• No starting up order detection (with transmitter <b>UDE</b>) in «starting up area» or</li> <li>• <b>UDF</b> modules no power supplied or badly linked to the receiver.</li> </ul>	<ul style="list-style-type: none"> <li>• Place the <b>UDE</b> transmitter in «starting up area» and aim at the <b>UDF</b> module(s) or</li> <li>• Verify that receiver is power supplied or</li> <li>• Verify that <b>UDF</b> module(s) is(are) well linked to the receiver or</li> <li>• Contact the technical manager</li> </ul>
<b>Flashes</b> (during radio remote control startup)	The startup procedure has been correctly executed	/

## 9.1 «Standby mode» function

The safety function called «**Standby mode**» allows the automatic deactivation of the transmitter **UDE** (cut-off of the radio transmission) when the pushbuttons \* (**BPSV** or **BPDV** type, and «**On / Horn**») are not actuated for a period of **N** minutes.

This shutdown of the radio transmission causes a safety state of the receiver by **passive stop** (deactivation of the RS1 and RS2 safety relays as well as function relays).



### **Restart after activation of the «Standby mode» function :**

1. Press the stop palmswitch button on the transmitter.
2. Follow startup procedure described in chapter «[Starting the radio control](#)», page [48](#)



### **Changing the time delay of «Standby mode» function :**

The duration **N** of the delay can be modified by a trained and authorized operator, follow the procedure described in the chapter «[Procedure: time delay for the «Standby mode» function](#)», page [44](#)

Parameter **N** can take values from 01 to 98 minutes.

If the **N** value configured is 99 minutes, the transmitter considers that the time delay is infinite (until the battery is entirely discharged).

On delivery, the duration is defined for 4 minutes.

\* = Rotary switches **COM2**, **COM3**, **COM3R** and **BPTR** do not act on the «Standby mode» function. The manipulation of these types of buttons does not rearm the temporization.

If the operator has to use switches during a long period, the temporization must be lengthened or removed by programming, or the operator will have to rearm the temporization by pressing regularly on the «On/Horn» button or another pushbutton type

## 10.1 «start-up by IR validation» option

Safety feature requiring IR validation to start up a remote controlled equipment can be used.

This option is available on **URR** and **UDR** receivers.

- To start the unit, the operator is required to point the transmitter toward the IR module **UDF** installed on the equipment to be controlled (see positioning below). This ensures an error-free match-up between the transmitter and the equipment to be controlled.
- The IR start-up field of action has a range of 0 to 25 m (see Fig. A).
- 1 infrared module **UDF** can be connected to the receiver **URR**.
- 1 to 3 infrared modules **UDF** can be connected to the receiver **UDR**.

**IMPORTANT :** the wiring of the IR module(s) **UDF** must be separate from the power cables and all other sources which may generate interference (power regulator, for example).

### Positioning of infrared modules **UDF** and IR range :

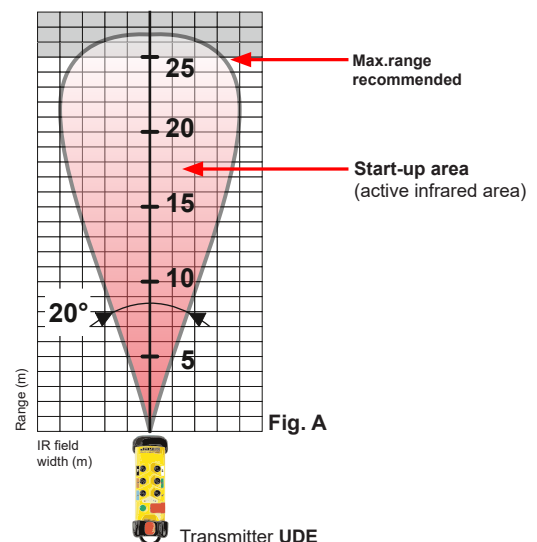
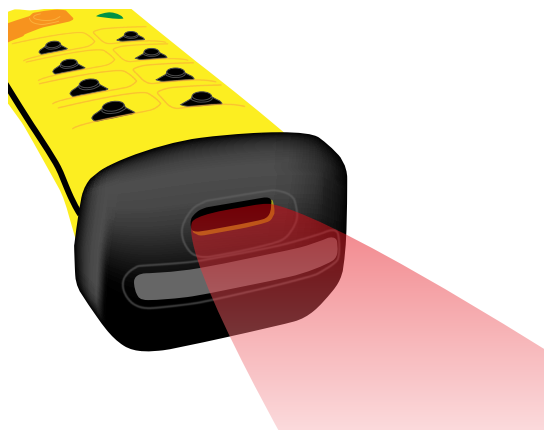
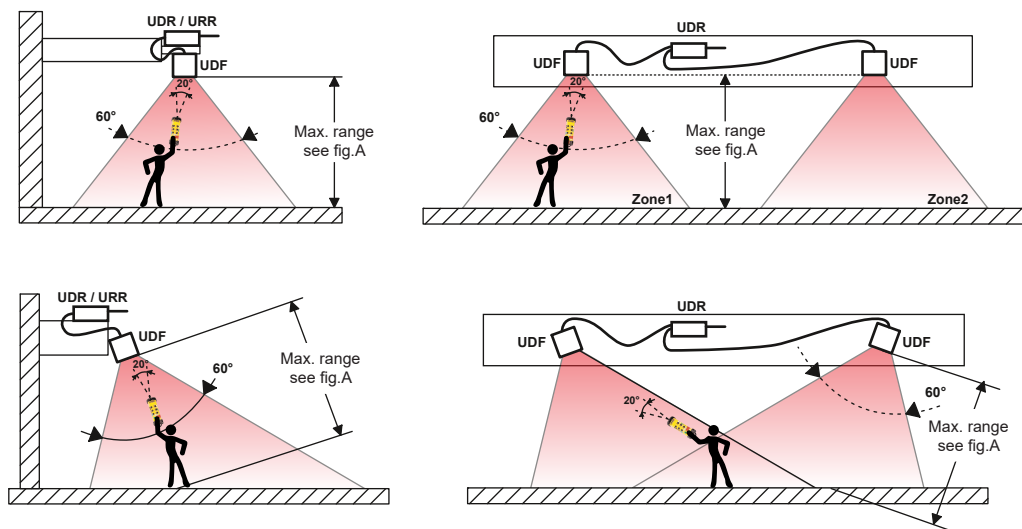



## 10.2 «Transmitter/Receiver association on start-up» option

This option allows the operator to select the receiver(s) to be controlled.

During the start-up phase (transmitter switched on), an encoded infrared message is transmitted to the receiver(s) pointed to by the operator. This option thus enables several transmitters (with difference id code and frequency) to successively take control of the receiver(s).

This is particularly useful when several receivers are implemented and you wish to operate any receiver with any transmitter with no mutual interference. This feature also allows you to select two receivers with one transmitter and have them operate simultaneously.

The infrared aiming characteristics are the same as those of the «start-up by infrared validation» option.

This option is only available on the receiver **UDR**.

- To start the unit, the operator is required to point the transmitter toward the IR module **UDF** installed on the equipment to be controlled (see positioning below). This ensures an error-free match-up between the transmitter and the equipment to be controlled.
- To «release» previously used equipment and to be able to work with other receivers, the operator must operate the stop palmswitch button of the transmitter **UDE**.
- The IR start-up field of action has a range of 0 to 25 m (see Fig. A on previous page).
- 1 to 3 infrared modules **UDF** can be connected to the receiver **UDR**.

**IMPORTANT** : the wiring of the IR module(s) **UDF** must be separate from the power cables and all other sources which may generate interference (power regulator, for example).

### Synoptic of operation: example for an overhead conveyor

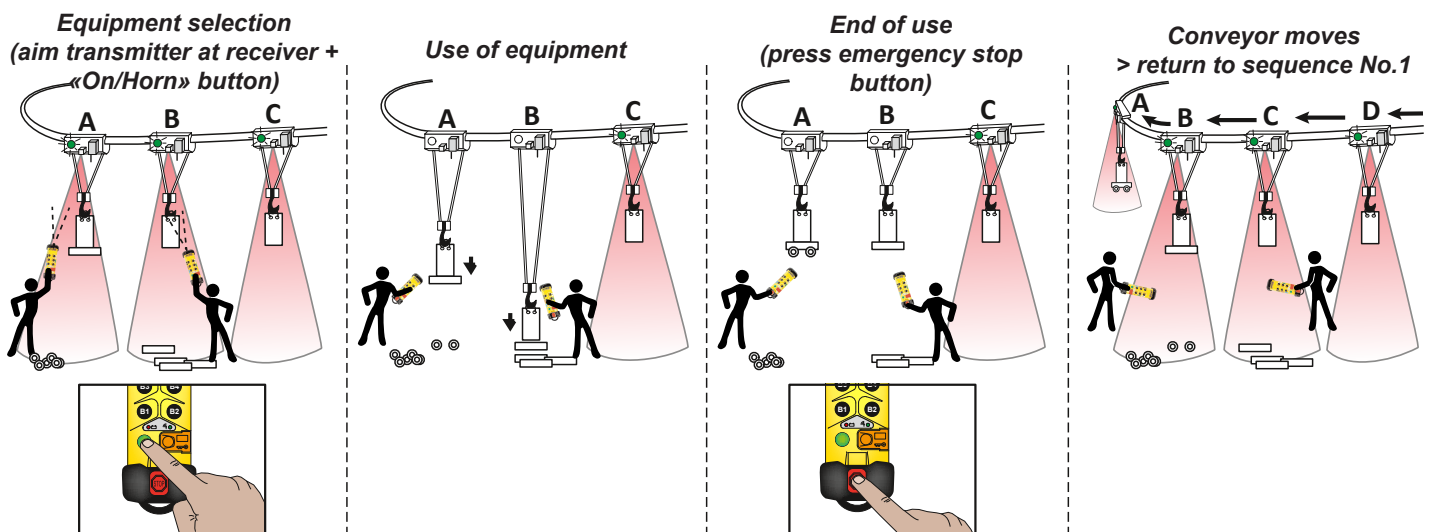

# 11 - «Plug-in antenna» kit OWR02



## CAUTION



To avoid any risks of electrocution, don't open the receiver housing when powered. The opening of the housing must be done by ensuring that the power supply cables and control cables are out of voltage.

Kit OWR02

### 11.1 Description of the kit OWR02

The «plug-in antenna» kit is intended for **URR** and **UCR** receivers which both have a fixed antenna.

This kit adds a BNC plug-in antenna connector instead of the fixed antenna output.

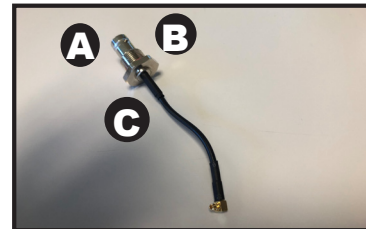

### 11.2 Installation on URR or UCR receiver

<b>1</b>	Open the receiver housing.	
<b>2</b>	Remove the fixed antenna by disconnecting the antenna wire from the Tuner and unscrewing the fixed antenna connector from the receiver housing.	
<b>3</b>	Place the BNC connector (A). Connect the antenna wire and the ground wire to the pins shown opposite.	
<b>4</b>	Place the serrated washer (B) and tighten the nut (C) with a flat wrench.	
<b>5</b>	Close the receiver housing. A BNC antenna or BNC extension can be installed now.	

# 12 - Technical data

## 12.1 Transmitter UDE

### 12.1.1 Technical characteristics

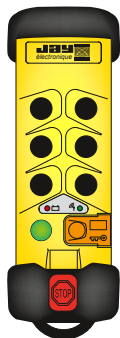
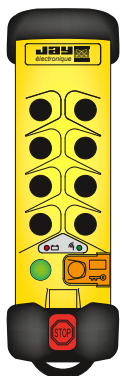
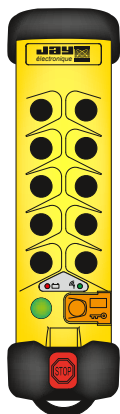

Mechanical, functional and environmental characteristics	
<b>Housing</b>	ABS Choc, Yellow, IP65 - Mechanical protection of the buttons
<b>Weight</b> (with battery)	Housing model «6+2 buttons» : 400 g Housing model «8+2 buttons» : 450 g Housing model «10+2 buttons» : 490 g
<b>Dimensions</b>	Housing model «6+2 buttons» : 232 x 82 x 64 mm Housing model «8+2 buttons» : 251 x 82 x 64 mm Housing model «10+2 buttons» : 288 x 82 x 64 mm
<b>Operating temperature range</b>	- 20°C to + 50°C
<b>Storage temperature range</b>	without battery : - 30°C to +70°C with battery : - 30°C to +35°C
<b>Attachment when idles</b>	Wall (by handle) or belt (by clip)
Electrical and radio characteristics	
<b>Power supply</b>	Plug-in <b>UDB2</b> (standard) or <b>UWB</b> (fast charge)
<b>Endurance transmit time/buttons typical average use (at +25°C)</b>	433-434MHz bands: 24 hours / 50% transmit time 869 and 911-918MHz : 20 hours / 50% transmit time
<b>Radio frequency</b> (see table in chapter «Radio frequency tables», page 40)	64 user-programmable in 433-434MHz bands 12 user-programmable in 869MHz band 64 user-programmable in 911-918MHz bands
<b>Transmit power</b> (built-in antenna)	<10 mW (license not required) in 433-434MHz and 869MHz bands <94 dBµV/m in 911-918MHz bands
<b>Modulation</b>	FM
<b>Average range with with antenna VUA001A or VUA001B on UDR receiver (1)</b>	100m in typical industrial environment 300m in unobstructed area
Functionnal characteristics	
<b>Functions</b>	6 differents kinds of fonctions buttons : - One-step pushbutton (single speed) : <b>BPSV</b> - Two-step pushbuttons (double speed) : <b>BPDV</b> - Rotary switch with 2 fixed positions : <b>COM2</b> - Rotary switch with 3 fixed positions : <b>COM3</b> - Rotary switch with 3 positions with auto. return : <b>COM3R</b> - Electronic switch with 3 fixed positions : <b>BPTR</b> 1 pushbutton «On/Horn» 1 active priority stop palmswitch button 1 electronic key
<b>«Standby mode» function</b> (Automatic shutdown of the transmitter and setting the receiver in safety mode)	User-programmable time delay, in 1 minute increments
<b>Indicator lights</b>	1 red indicator light «battery level» and diagnostic 1 green indicator light «On» and diagnostic

(1)= Range will vary according to environment conditions of transmitter and reception antenna (metal frameworks, walls...).

### 12.1.2 Function button interlockings

The following function button interlocking configurations are possible :

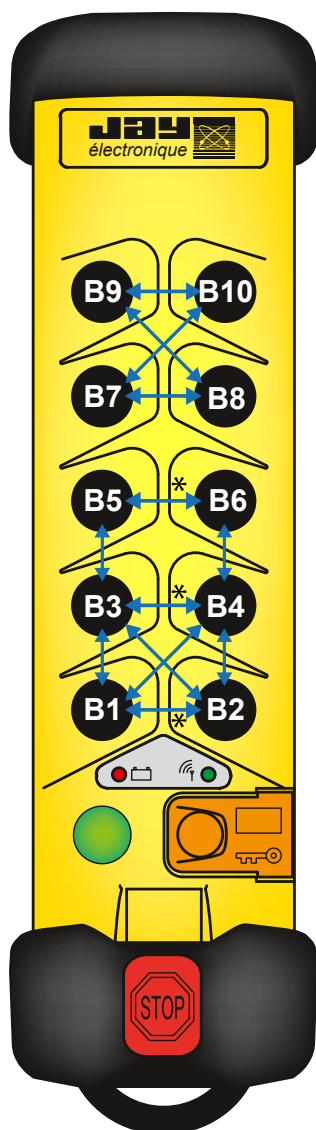

1st button of interlocked pair	2nd button of interlocked pair	Acronym
Button No.1	Button No.2	B1-B2*
Button No.1	Button No.3	B1-B3
Button No.1	Button No.4	B1-B4
Button No.2	Button No.3	B2-B3
Button No.2	Button No.4	B2-B4
Button No.3	Button No.4	B3-B4*
Button No.3	Button No.5	B3-B5
Button No.4	Button No.6	B4-B6
Button No.5	Button No.6	B5-B6*
Button No.7	Button No.8	B7-B8
Button No.7	Button No.10	B7-B10
Button No.8	Button No.9	B8-B9
Button No.9	Button No.10	B9-B10

\* = Standard interlocking configurations defined in sales reference for UDR receiver (if choosing a unit in separate elements, see ref. : **E330** sales documentation).

For each of the desired interlocking configurations, simultaneous action on the two buttons will result in three operating modes which depend on the programs defined:

- **program «1»** : By pressing the 2 button pair, the two commands are deactivated (corresponding relays set to OFF).
- **program «2»** : The first button of the interlocked pair has priority (ex.: button No.1 and button No.2 interlocked: when these two buttons are pressed simultaneously, only button No.1 is acknowledged)
- **program «3»** : The 2nd button of the interlocked pair has priority (ex.: button No.2 and button No.4 interlocked: when these two buttons are pressed simultaneously, only button No.4 is acknowledged)
- **program «X»** : special (according to a customization data sheet).

### 12.3 Standard battery UDB2



Mechanical, functional and environmental characteristics	
Housing	ABS Choc, Yellow IP40
Technology	NiMH
Dimensions	40 x 96 x 23 mm
Storage temperature range	-30°C to +35°C
Charging temperature	0°C to +45°C
Complete charging time	14 Hours
Indicator lights	<b>Charging :</b> 1 red light indicator on the battery <b>Charge status :</b> 1 red light indicator on transmitter (low battery charge level)
Power supply	by charger <b>UBCU</b> (110-230VAC / 12VDC) by connector <b>UBC1</b> (10 to 30VDC)

### 12.4 Fast charge battery UWB



Mechanical, functional and environmental characteristics	
Housing	ABS Choc, Black IP40
Technology	NiMH
Dimensions	40 x 96 x 23 mm
Storage temperature range	-20°C to +35°C
Charging temperature	0°C to +35°C
Complete charging time	7 Hours
Partial charge time (at 20°C)	10 mn of charge get approx. 1 hour of autonomy 1 hour of charge gets approx. 8 hours of autonomy 6 hours of charge get approx. 12 hours of autonomy
Indicator lights	<b>Charging :</b> 1 «2-color» indicator light on the battery pack: Orange = fast charge Green = slow charge and up-keep charge <b>Charge status :</b> 1 red light indicator on transmitter (low battery charge level)
Power supply	By charger <b>UCCU</b> (110-230VAC / 5VDC) By voltage adapter <b>UCC1</b> (6V)

## 12.5 Receiver URR

### 12.5.1 Receiver URR technical characteristics



Mechanical and environment withstand characteristics	
Housing	ABS, Grey, IP65
Weight	1,1 Kg approx.
Dimensions	200 x 120 x 75 mm (without antenna and cable glands)
Operating temperature range	-20°C to +50°C
Storage temperature range	-30°C to +70°C
Cable lead-outs	Control outputs : 1 M25 plastic cable gland (cable diameter Ø 14 to 20 mm) Power supply or IR module : 1 M16 cover (cable diameter Ø 5 to 7 mm) (2)
Connection	Spring-type terminal strips for 0.08 <sup>2</sup> to 2.5 <sup>2</sup> section wires
Radio characteristics (complying with EN 300 220)	
Radio frequencies	64 user-programmable frequencies in 433-434MHz
Fixed antenna (3)	1/4 wave for 433-434 MHz bands Option: 1/2 wave with antenna extension
Sensitivity	< -100 dBm
Electrical characteristics	
Power supply and consumption	<b>DC version:</b> 12VDC, -5% to +30%, 550 mA 24VDC, -20% to +20%, 430 mA  <b>AC No 1 version:</b> 24VAC, -15% to +10%, 1 A 48VAC, -15% to +10%, 475 mA  <b>AC No 2 version:</b> 115VAC, -15% to +10%, 200 mA 230VAC, -15% to +10%, 90 mA
With : 2 safety relays, the «Horn» relay and 6 function relays pulled in	
Control	1 «Horn» relay + 6 function relays
Safety	2 relays with linked and guided contacts
Outputs	Independent 1 NO contact relays - Category DC13 0,5 A / 24 VDC , AC15 2 A / 230 VAC (tests according to EN 60947-5-1) - Max. breaking capacity. 2000 VA - Max. current 8A (control relay, Horn), 6 A (safety relays) - Min. current 10 mA (12 Vmin.) - Max. voltage 250 VAC - Service life with 230VAC, 70VA, cosphi=0,75 : Control relay, Horn relay : 3x10 <sup>6</sup> cycles Safety relays : 4,5x10 <sup>6</sup> cycles
Response time	- On start-up : 0,5 s max. - On control : 70 ms max.
Active shutdown time	160 ms max.
Passive shutdown time	1,15 s max.
Indicator lights	1 green indicator light : receiver power supply 1 red + 1 green diagnostic indicator lights 1 red status indicator light per relay
Power supply protection	Against polarity inversions for DC version Against overcurrent by fuse

(1)= Optional Infrared Module

(2)= The cover can be replaced by a plastic cable gland (standard PE) type M16 mounted in its place. The UDF infrared module is systematically delivered with one plastic M16 cable gland.

(3)= Possibility of using a BNC plug-in antenna and antenna extension with kit ref. : **OWR02**, see chapter «**Plug-in antenna» kit OWR02**»

### 12.5.2 Fuse characteristics on receiver URR

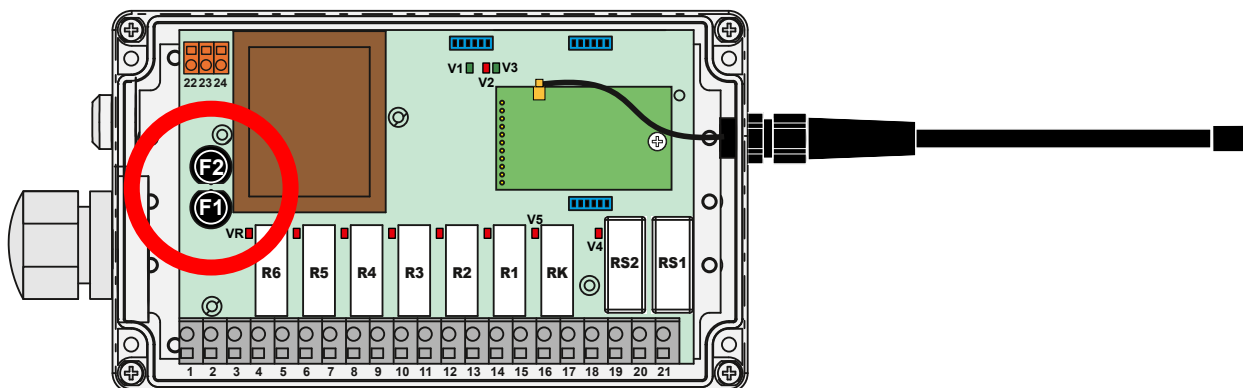

Receiver power supply <b>CAUTION</b> : Depending on receiver model !	Fuse characteristics (5x20)	Location of fuse to be used
Receiver supplied with 12 VDC	1 A / 250 VAC / T	F1
Receiver supplied with 24VDC	1 A / 250 VAC / T	F2
Receiver supplied with 24VAC	1.6 A / 250 VAC / T	F2
Receiver supplied with 48VAC	800 mA / 250 VAC / T	F1
Receiver supplied with 115VAC	315 mA / 250 VAC / T	F2
Receiver supplied with 230VAC	160 mA / 250 VAC / T	F1

## 12.6 Receiver UCR

### 12.6.1 Receiver UCR technical characteristics



Mechanical and environment withstand characteristics	
Housing	ABS, Grey, IP65
Weight	1,2 Kg approx.
Dimensions	120 x 240 x 100 mm (without antenna and cable glands)
Operating temperature range	-20°C to +50°C
Storage temperature range	-30°C to +70°C
Cable lead-outs	Control outputs : 1 M32 plastic cable gland (for cable diameter Ø 20 à 26 mm) Power supply : 1 M16 cover (for cable diameter Ø 5 to 7 mm) (1)
Connection	Spring-type terminal strips for 0.08 <sup>2</sup> to 2.5 <sup>2</sup> section wires
Radio characteristics (complying with EN 300 220)	
Radio frequencies	64 user-programmable frequ. in 433-434MHz bands 12 user-programmable frequ. in 869 MHz band
Fixed antenna (2)	1/4 wave for 433-434 MHz and 869 MHz bands Option: 1/2 wave with antenna extension
Sensitivity	Better than -100 dBm
Electrical characteristics	
Power supply and consumption	<b>DC version:</b> 12VDC, 0 to +25%, 675mA and 188mA idle 24VDC, -15% to +20%, 675mA and 188mA idle
With : 2 safety relays, the «Horn» relay and 5 function relays pulled in	<b>AC version:</b> 48 VAC, -15% to +10%, 550 mA 230 VAC, -15% to +10%, 70 mA
Control	12 relays + 1 «Horn» relay
Safety	2 relays with linked and guided contacts
Number of output relays simultaneously controllable	8 (including «RS1-RS2» safety relays and the «horn» relay)
Outputs	Independent 1 NO relays - Category DC13 0,5 A / 24 VDC , AC15 2 A / 230 VAC (tests according to EN 60947-5-1) - Max. breaking capacity: 2000 VA - Max. current: 8A (control relays and «Horn» relay), 6 A («Safety» relays) - Min. current: 10 mA (12 Vmin.), 100 mA recommended - Max. voltage: 250 VAC - Service life with 230 VAC, 70 VA, cosphi=0,75 : Control relay, Horn relay : 3x10 <sup>6</sup> cycles Safety relays : 4,5x10 <sup>6</sup> cycles
Response time	- On start-up : 0,5 s max. - On control : 70 ms max.
Active shutdown time	160 ms max.
Passive shutdown time	1,15 s max.
Indicator lights	1 green indicator light : receiver power supply 1 red + 1 green diagnostic indicator lights 1 red status indicator light per relay
Power supply protection	- Against overcurrent by fuse

(1)= The cover can be replaced by a plastic cable gland (standard PE) type M16 mounted in its place.

(2)= Possibility of using a BNC plug-in antenna and antenna extension with kit ref. : **OWR02**, see chapter «**Plug-in antenna**» kit **OWR02**»



## (12 - Technical data)

### 12.6.2 Fuse characteristics on receiver UCR

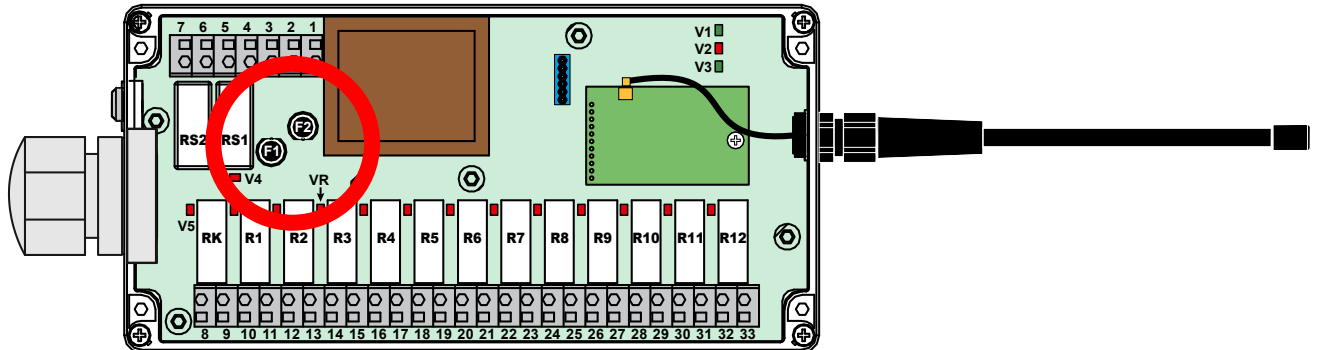

Receiver power supply <b>CAUTION</b> : Depending on receiver model !	Fuse characteristics (5x20)	Location of fuse to be used
Receiver supplied with 12 VDC	1 A / 250 VAC / T	F1
Receiver supplied with 24VDC	1 A / 250 VAC / T	F2
Receiver supplied with 48VAC	800 mA / 250 VAC / T	F2
Receiver supplied with 230VAC	160 mA / 250 VAC / T	F1

## 12.7 Receiver UDR

### 12.7.1 Receiver UDR technical characteristics



Mechanical and environment withstand characteristics	
Housing	ABS, Grey, IP65
Weight	2 Kg approx.
Dimensions	160 x 250 x 120 mm (without antenna and cable glands)
Operating temperature range	-20°C to +50°C
Storage temperature range	-30°C to +70°C
Cable lead-outs	Control: 1 plastic cable gland M32 (Ø 20 to 26 mm cables) IR Modules: 3 cover M16 (Ø 5 to 7 mm cables) (2) Power supply: 1 cover M16 (Ø 5 à 7 mm cables) (2)
Connection	Spring-type terminal strips for 0.08 <sup>2</sup> to 2.5 <sup>2</sup> section wires
Radio characteristics (complying with EN 300 220)	
Radio frequencies	64 user-programmable frequ. in 433-434MHz bands 12 user-programmable frequ. in 869 MHz band 64 user-programmable frequ. in 911-918MHz bands
Antennas	1/4 wave for 433-434, or 869, or 911-918 MHz bands. Option 1/2 wave with antenna extension
Sensitivity	< -100 dBm
Electrical characteristics	
Power supply and consumption (3)	<b>DC version:</b> 12VDC, 0 to +25%, 675mA and 188mA idle 24VDC, -15% to +20%, 675mA and 188mA idle <b>With :</b> <b>2 safety relays, 8 function relays pulled in, and 3 IR UDF modules connected to receiver</b> <b>AC No 1 version:</b> 24VAC, -15% to +10%, 850 mA 48VAC, -15% to +10%, 400 mA <b>AC No 2 version:</b> 115VAC, -15% to +10%, 180 mA 230VAC, -15% to +10%, 85 mA
Control	1 «Horn» relay + 12 or 18 function relays
Safety	2 relays with linked and guided contacts
Outputs	Independent 1 NO relays - Category DC13 0,5 A / 24 VDC , AC15 2 A / 230 VAC - Max. breaking capacity: 2000 VA - Max. current: 8A (control relays and «Horn» relay), 6 A («Safety» relays) - Min. current: 10 mA (12 Vmin.), 100 mA recommended - Max. voltage: 250 VAC - Service life with 230 VAC, 70 VA, cosphi=0,75 : Control relay, Horn relay : 3x10 <sup>6</sup> cycles Safety relays : 4,5x10 <sup>6</sup> cycles
Response time	- On start-up : 0,5 s max. - On control : 55 ms max.
Active shutdown time	145 ms max.
Passive shutdown time	1,1 s max.
Indicator lights	- 1 red «power on» indicator light - 1 red indicator light + 1 green diagnostic indicator light - 1 red status indicator light per relay
Power supply protection	- Against polarity inversions for DC versions - Against overcurrents by fuse

(1)= Optional Infrared Modules

(2)= The cover can be replaced by a plastic cable gland (standard PE) type M16 mounted in its place. The UDF infrared module is systematically delivered with one plastic M16 cable gland.

(3)= The number of function relays controlled simultaneously is limited to 10 relays with 1 UDF module connected to UDR receiver, or to 9 relays with 2 UDF modules connected, or to 8 relays with 3 UDF modules connected.

12.7.2 Fuse characteristics on receiver UDR

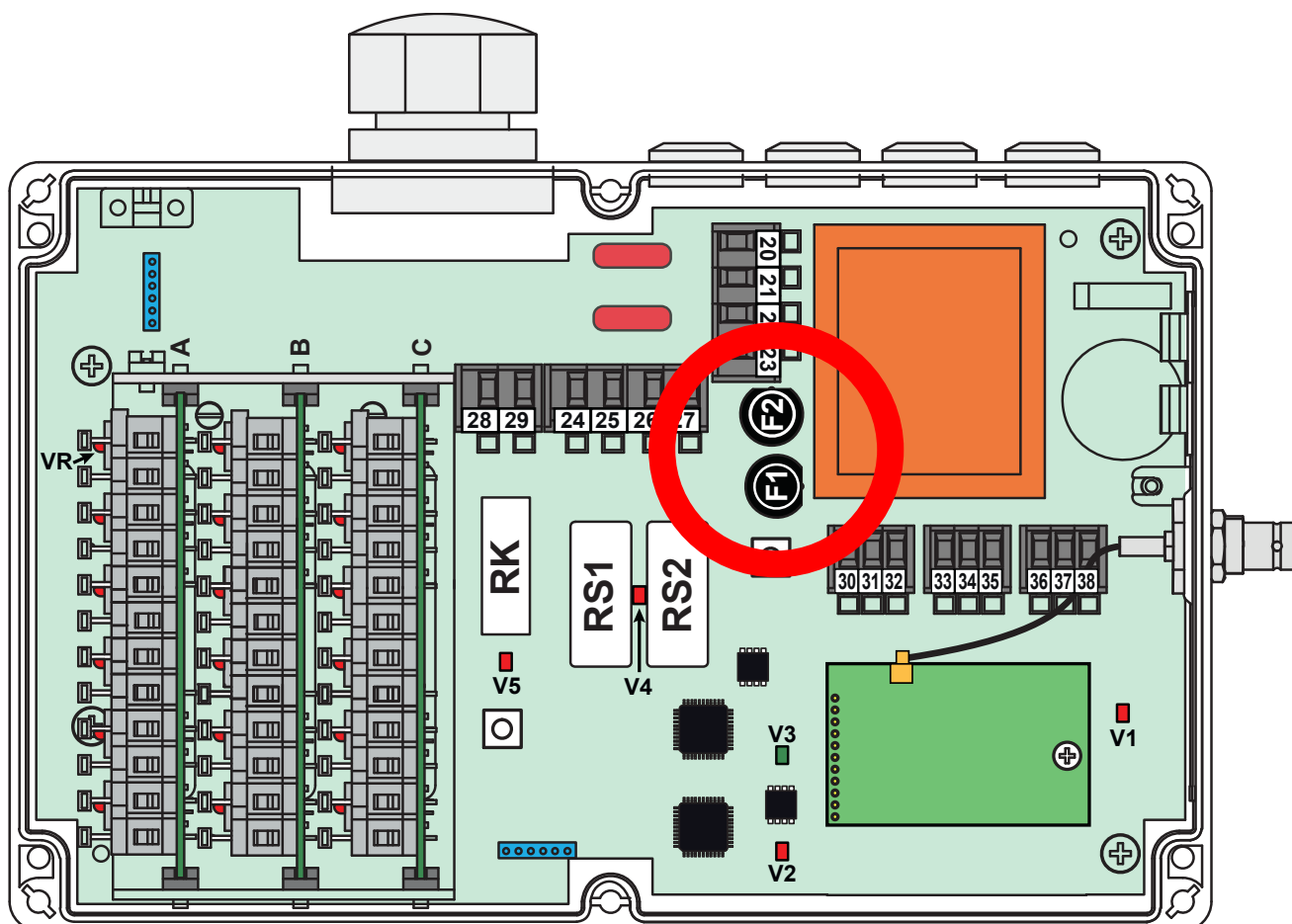

Receiver power supply <b>CAUTION :</b> Depending on receiver model !	Fuse characteristics (5x20)	Location of fuse to be used
Receiver supplied with 12 VDC	1 A / 250 VAC / T	F2
Receiver supplied with 24VDC	1 A / 250 VAC / T	F1
Receiver supplied with 24VAC	1,6 A / 250 VAC / T	F2
Receiver supplied with 48VAC	800 mA / 250 VAC / T	F1
Receiver supplied with 115VAC	315 mA / 250 VAC / T	F2
Receiver supplied with 230VAC	160 mA / 250 VAC / T	F1

## 12.8 BNC plug-in antennas - use in 433-434MHz bands

<p>Antenna reference: <b>VUA001A</b> Type: straight, 1/4 wave, BNC connection Approximate length: 190mm</p>	 <p>Antenna supplied as standard with the Transceiver UDR</p>
<p>Antenna reference: <b>VUA002A</b> Type: straight, 1/2 wave, BNC connection Approximate length: 335mm</p>	
<p>Antennas references: • <b>VUA100AH</b> (with 0,5m cable) • <b>VUA102AH</b> (with 2m cable) • <b>VUA105AH</b> (with 5m cable) • <b>VUA110AH</b> (with 10m cable) Type: through insulated remote, 1/2 wave, BNC connection Approximate length: 320mm Required drill hole: 15mm</p>	
<p>Antennas references: • <b>VUA103AM</b> (with 3m cable) • <b>VUA105AM</b> (with 5m cable) Type: insulated magnetic remote, tuned, BNC connection Approximate length: 440mm</p>	
<p>Antennas references: • <b>VUA103AV</b> (with 3m cable) • <b>VUA105AV</b> (with 5m cable) Type: through uninsulated remote, 1/4 wave, BNC connection Approximate length: 180mm Required drill hole: 12mm or 19mm (ring 2 diameters supplied)</p>	
<p>Antenna reference: • <b>VUA102CP</b> (with 2m cable) Type: flat, BNC connection Required drill hole: 12mm</p>	

## 12.9 BNC plug-in antennas - use in 869MHz and 911-918MHz bands

<p>Antenna reference: <b>VUA001B</b>  Brand name: EBDS  Frequency Range: 890-960 MHz  Antenna gain: 1.5 dBi (need grounded 16x16cm)  Type: straight, 1/4 wave, BNC connection  Approximate length: 180mm</p>	 <p>Antenna supplied as standard with the Transceiver UDR</p>
<p>Antenna reference: <b>VUA002B</b>  Brand name: PROCOM  Frequency Range: 890-960 MHz  Antenna gain: 5 dB (compared to 1/4 wave)  Type: straight, 1/2 wave, BNC connection  Approximate length: 250mm</p>	
<p>Antennas references:  <ul style="list-style-type: none"> <li>• <b>VUA100BH</b> (with 0,5m cable)</li> <li>• <b>VUA102BH</b> (with 2m cable)</li> <li>• <b>VUA105BH</b> (with 5m cable)</li> <li>• <b>VUA110BH</b> (with 10m cable)</li> </ul> Brand name: ASTEL  Frequency Range: 860-960 MHz  Antenna gain: 4 dBi  Type: through insulated remote, 1/2 wave, BNC connection  Approximate length: 190mm  Required drill hole: 15mm</p>	
<p>Antennas references:  <ul style="list-style-type: none"> <li>• <b>VUA103BM</b> (with 3m cable)</li> <li>• <b>VUA105BM</b> (with 5m cable)</li> </ul> Brand name: ASTEL  Frequency Range: 806-870 MHz  Antenna gain: 5 dBi (need grounded 60x60cm)  Type: insulated magnetic remote, tuned, BNC connection  Approximate length: 320mm</p>	
<p>Antennas references:  <ul style="list-style-type: none"> <li>• <b>VUA103BV</b> (with 3m cable)</li> <li>• <b>VUA105BV</b> (with 5m cable)</li> </ul> Brand name: ASTEL  Frequency Range: 900-920 MHz  Antenna gain: 2 dBi  Type: through uninsulated remote, 1/4 wave, BNC connection  Approximate length: 100mm  Required drill hole: 12mm or 19mm (ring 2 diameters supplied)</p>	

**BEFORE STARTING ANY SERVICING OPERATION, SWITCH OFF THE MAIN POWER SUPPLY FOR THE SYSTEM CONTROLLED**

## 13.1 Servicing the UDE transmitter



- **Housing of the UDE transmitter must not be opened.** The UDE transmitter can be dismantled only by a trained staff, in a suitable environment, spare parts can be changed only by identical and original parts.



- **If one of the membranes of the function buttons or the seal of the transmitter is damaged, the transmitter must not be any more used until replacement of these tightness spare parts.**

In opposite case, any liquid, any dust or any foreign body can damage the transmitter.

- The attention of the user is attracted to the risks of the use of the remote control in an environment containing solvents of polymers or glues which can degrade the good functioning of transmitter mechanical components.
- Verify regularly the good state of the transmitter, paying a special attention to the function button membranes, to the electronic key connector and to the battery connector.
- Clean the transmitter by eliminating any foreign body. **Use only non-aggressive cleansers based on soapy solution.**

## 13.2 Servicing the receiver URR/UCR/UDR

- Check the following points:
  - ◇ The electrical connection of the receiver to the equipment to be controlled.
  - ◇ Contacts of function relays.
  - ◇ Correct operation of stop circuits, active and passive.
  - ◇ Condition of cover seal, tightening of screws and cable glands and tightness of antenna (check that it is clean and if BNC connector is present, check that it is not oxidized).
- Clean the receiver by eliminating any foreign body.  
**Use only non-aggressive cleansers based on soapy solution.**
- **To check operation of the active stop function** (UD system started up) : simply press the stop palmswitch button on the transmitter. The safety relays of the receiver must then be deactivated immediately.
- **To check operation of the passive stop function** (UD system started up) : simply remove the electronic key **or** remove the battery from the transmitter **or** wait until «Standby mode» function is activated (automatic shutdown of the transmitter), the safety relays of the receiver must then be deactivated within 2 seconds

## 14 - FCC compliance

UDEE / UDRE complies with Part 15 of the FCC Rules. Operation is subject to the following two conditions:

(1) this device may not cause harmful interference,

and

(2) this device must accept any interference received, including interference that may cause undesired operation.

The user that changes or modifications not expressly approved by the party responsible for compliance could void the user's authority to operate the equipment.

This equipment has been tested and found to comply with the limits for a Class B digital device, pursuant to Part 15 of the FCC Rules. These limits are designed to provide reasonable protection against harmful interference in a residential installation. This equipment generates, uses and can radiate radio frequency energy and, if not installed and used in accordance with the instructions, may cause harmful interference to radio communications. However, there is no guarantee that interference will not occur in a particular installation. If this equipment does cause harmful interference to radio or television reception, which can be determined by turning the equipment off and on, the user is encouraged to try to correct the interference by one or more of the following measures:

- Reorient or relocate the receiving antenna.
- Increase the separation between the equipment and receiver.
- Connect the equipment into an outlet on a circuit different from that to which the receiver is connected.
- Consult the dealer or an experienced radio/TV technician for help.

## 15 - Warranty

**All our products are guaranteed two years as of date of product manufacture (indicated on product), excluding wear parts. For the battery, the warranty period is limited to 1 year. Repair, modification or replacement of a device during the warranty period may not have the effect of extending the warranty period.**

### **Limits of warranty:**

The warranty does not cover defects resulting from :

- transport
- false manoeuvre or non-observance of connection diagrams when setting the equipment into service
- insufficient supervision or servicing, utilization not complying with the specifications detailed in the technical manual and, as a general rule, storage, operation or environment conditions (atmospheric, chemical, electrical or other conditions).
- Conditions not specified on order of the equipment

The warranty shall not apply subsequent to any modifications or additions to the equipment performed by the customer without written approval by JAY Electronique.

The JAY Electronique responsibility during the warranty period is limited to material and construction defects. This warranty comprises repair in the JAY workshops or replacement, free of charge, of parts recognized to be defective following expert inspection by the Jay Technical Department.

The warranty shall not give rise to any compensation for damage claims.

Any disputes relative to a supply or settlement thereof shall be ruled by the COURT OF COMMERCE OF GRENOBLE, solely competent, even in the event of an Appeal or a plurality of defendants

## 16 - Waste recycling and management



When the unit has reached the end of its service life, be sure to dispose of it appropriately. The unit can be disposed of in a specific waste collection centre as organised by the local authorities, or it can be turned over to a distributor who will handle proper disposal of the unit.

Electronic waste sorting will prevent possible negative impact on the environment resulting from inappropriate elimination of electronic waste and will allow proper processing and recycling of the materials forming the unit, representing significant savings in terms of energy and resources.

## 17 - Product references

See product sales documentation ref.: **E330** «UD Series»

## 18 - Warning, avoid any mutual disturbance

Be certain that the UD System doesn't disturb other systems and that it is not being disturbed itself by other Systems.

Use different radio frequencies if several radio control systems are used on the same site.

## 19 - Manufacturer information



Manufacturer and plant:  
JAY électronique  
ZAC la Bâtie, rue Champrond  
F38330 SAINT ISMIER  
Tel: +33 (0)4 76 41 44 00  
[www.jay-electronique.com](http://www.jay-electronique.com)



# 20 - CE Declaration of conformity

## 20.1 Transmitter UDE

Translated from French

### DECLARATION OF CONFORMITY

EN

The manufacturer :

**JAY Electronique**  
**ZAC la Bâtie, rue Champrond**  
**38334 ST ISMIER Cedex**  
**FRANCE**

Declares that the transmitter described in the user manual and mentioned here below:

### **UDE**

Complies:

- With the requirements specified for the machines defined in Appendix I of the Directive 2006/42/EC concerning alignment of the legislation of the member states relative to machinery on the basis of compliance with the following standards :

- EN ISO 13849-1 :2015 Requirements for performance level PL d (Category 3)
- EN 62061 :2005 + AC :2010+A1 :2013+ A2 :2015 Requirements for SIL 2
- IEC 61508 Parts 1 to 3 :2010 Requirements for SIL 2
- EN ISO 13850 (2015) Clause 4.14 Stop category 0
- EN 60204-1 :2006+ A1 :2009 + AC :2010, Paragraph 9.2.2 category 0.
- EN 60947-5-1 :2004 + AC :2005 + A1 :2009
- EN 13557+A2 :2008 Paragraphs 5.1 ; 5.2.3 and Annex C.

This equipment can be used in applications up to Category 3 (PL d) according to EN ISO 13849-1 and SIL 2 according to EN 62061 and EN 61508. For its safety stop, when combined with the appropriate receiver.

- With the requirements of the European Directive 2014/53/EU of the Council of Europe of April 16th 2014, concerning the alignment of the legislations of the member states, relative to radio equipment and telecommunication terminals with special reference to:
  - article 3.1 a, concerning the protection requirements of the health and safety of people and domestic animals, and the protection of property with Directive 2014/35/EU according to the following standards : EN 60950-1 :2006 + A11 :2009 + A1 :2010 + A12:2011 + AC :2011 + A2 : 2013 et EN 62479 :2010
  - l'article 3.1 b, covering the requirements relative to protection as concerns electromagnetic compatibility, with Directive 2014/30/EU.
  - l'article 3.2, covering the requirements relative to proper use of the radio-frequency spectrum.

To this end, the notified body n°0573:

**AEMC Lab**  
**19, rue François Blumet**  
**ZI de l'Argentière**  
**38330 SASSENAGE**  
**FRANCE**

Conducted testing of the above transmitter unit for Electromagnetic Compatibility (3.1b) and for compliance with the spectrum (3.2), according to following standards:

- EN 301 489-3 V1.6.1
- EN 301 489-1 V1.9.2
- EN 61000-6-2 : 2005
- EN 300 220-2 V3.1.1
- EN 62479 :2010
- EN 62061 Annex E :2005

included in the reports : nb.**R1412371R2-E-A1**, and nb.**R1412371C2-E**.

- With the requirements of the European Directive of the Council of Europe dated June 8, 2011, relative to the limitation of use of certain dangerous substances in electrical and electronic equipment (RoHS), (2011/65/EU).
- With the requirements of the European Directive of the Council of Europe dated July 4, 2012, relative to electrical and electronic equipment waste (WEEE), (2012/19/EU).

**Signatory:** Responsible person authorized to compile the technical file (2006/42 Annex II § 2), and empowered to draw up the declaration on behalf of the manufacturer (2006/42 Annex II § 10).  
This declaration of conformity is issued under the sole responsibility of the manufacturer:

**Name:** Pascal De Boissieu; **Function:** Technical Manager.

**Place and Date:** JAY Electronique ZAC Bâtie Street Champrond 38334 St Ismier France on 24/10/2017.

**Signature:** signed on original

320642C\_UDE

320642C\_UDE\_Declaration\_de\_conformite\_FR-EN-DE-IT-ES.docx

## 20.2 Receiver URR

Translated from French	<b>DECLARATION OF CONFORMITY</b>	
The manufacturer :		
<b>JAY Electronique</b> <b>ZAC la Bâle, rue Champrouf</b> <b>38334 ST ISMIER Cedex</b> <b>FRANCE</b>		
Declares that the receiver described in the user manual and mentioned here below:		
<b>URR</b>		
Complies:		
☒ With the requirements specified for the machines defined in Appendix I of the Directive 2006/42/EC concerning alignment of the legislation of the member states relative to machinery on the basis of compliance with the following standards :		
☒ EN ISO 13849-1 :2015 Requirements for performance level PL d (Category 3)		
☒ EN 62061 :2005 + AC :2010+A1 :2013+ A2 :2015 Requirements for SIL 2		
☒ IEC 61508 Parts 1 to 3 :2010 Requirements for SIL 2		
☒ EN ISO 13850 (2015) Classe 4.14 Stop category 0		
☒ EN 60204-1 :2006 + A1 :2009 + AC :2010, Paragraph 9.2.2 category 0		
☒ EN 60947-5-1 :2004 + AC :2005 + A1 :2009		
☒ EN 13357 A2 :2008 Paragraphs 5.1 ; 5.2.3 and Annex C.		
This equipment can be used in applications up to Category 3 (PL d) according to EN ISO 13849-1 and SIL 2 according to EN 62061 and EN 61508. For its safety outputs, when combined with the appropriate transmitter.		
☒ With the requirements of the European Directive 2014/53/EU of the Council of Europe of April 16th 2014, concerning the alignment of the legislations of the member states, relative to radio equipment and telecommunication terminals with special reference to:		
- article 3.1 a, concerning the protection requirements of the health and safety of people and domestic animals, and the protection of property with Directive 2014/53/EU according to the following standards : EN 60950-1 :2006 + A11 :2009 + A1 :2010 + A12:2011 + AC :2011 + A2 : 2013 or EN 62479 :2010		
- Article 3.1 b, covering the requirements relative to protection as concerns electromagnetic compatibility, with Directive 2014/30/EU,		
- Article 3.2, covering the requirements relative to proper use of the radio-frequency spectrum.		
To this end, the notified body n°0573:		
<b>AEMC Lab</b> <b>19, rue François Blomet</b> <b>ZI de l'Argentière</b> <b>38739 SASSENAGE</b> <b>FRANCE</b>		
Conducted testing of the above receiver unit for Electromagnetic Compatibility (3.1b) and for compliance with the spectrum (3.2), according to following standards:		
☒ EN 62061 :2005/ +A1 :2013+ A2 :2015	☒ EN 61326-1 : 2013	
☒ EN 61000-6-7 : 2013	☒ EN 300220-2 V3.1.1	
☒ EN 61000-6-2 : 2005	☒ EN 62479 :2010	
☒ EN 61000-6-2 : 2016	☒ Draft EN 301 489-3 V2.1.0	
☒ EN 61326-2-1 : 2017	☒ Draft EN 301 489-1 V2.2.0	
included in the reports : nb. <b>R1906199R2-E</b> , and nb. <b>R1906199C2-E-A1</b> .		
☒ With the requirements of the European Directive of the Council of Europe dated June 8, 2011, relative to the limitation of use of certain dangerous substances in electrical and electronic equipment (RoHS), (2011/65/EU).		
☒ With the requirements of the European Directive of the Council of Europe dated July 4, 2012, relative to electrical and electronic equipment waste (WEEE), (2012/19/EU).		
<b>Signatory:</b> Responsible person authorized to compile the technical file (2006/42 Annex II § 2), and empowered to draw up the declaration on behalf of the manufacturer (2006/42 Annex II § 10). This declaration of conformity is issued under the sole responsibility of the manufacturer: <b>Name:</b> Pascal De Boissieu; <b>Function:</b> Technical Manager. <b>Place and Date:</b> JAY Electronique ZAC Bâle Street Champrouf 38334 St Ismier France on 11/27/2019.		
<b>Signature:</b> signed on original		
329643 D_UR R	329643D_URR_Declaration.de.conformite.FR	EN CE IT ES

## 20.3 Receiver UCR

Translated from French

### DECLARATION OF CONFORMITY

EN

The manufacturer :

**JAY Electronique**  
**ZAC la Bâtie, rue Champrond**  
**38334 ST ISMIER Cedex**  
**FRANCE**

Declares that the receiver described in the user manual and mentioned here below:

### UCR

Complies:

- With the requirements specified for the machines defined in Appendix I of the Directive 2006/42/EC concerning alignment of the legislation of the member states relative to machinery on the basis of compliance with the following standards :

- ☒ *EN ISO 13849-1 :2015 Requirements for performance level PL d (Category 3)*
- ☒ *EN 62061 :2005 + AC :2010+A1 :2013+ A2 :2015 Requirements for SIL 2*
- ☒ *IEC 61508 Parts 1 to 3 :2010 Requirements for SIL 2*
- ☒ *EN ISO 13850 (2015) Clause 4.14 Stop category 0*
- ☒ *EN 60204-1 :2006+ A1 :2009 + AC :2010, Paragraph 9.2.2 category 0.*
- ☒ *EN 60947-5-1 :2004 + AC :2005 + A1 :2009*
- ☒ *EN 13557+A2 :2008 Paragraphs 5.1 ; 5.2.3 and Annex C.*

This equipment can be used in applications up to Category 3 (PL d) according to EN ISO 13849-1 and SIL 2 according to EN 62061 and EN 61508. For its safety outputs, when combined with the appropriate transmitter.

- With the requirements of the European Directive 2014/53/EU of the Council of Europe of April 16th 2014, concerning the alignment of the legislations of the member states, relative to radio equipment and telecommunication terminals with special reference to:
  - *article 3.1 a, concerning the protection requirements of the health and safety of people and domestic animals, and the protection of property with Directive 2014/35/EU according to the following standards : EN 60950-1 :2006 + A11 :2009 + A1 :2010 + A12:2011 + AC :2011 + A2 : 2013 et EN 62479 :2010*
  - *l'article 3.1 b, covering the requirements relative to protection as concerns electromagnetic compatibility, with Directive 2014/30/EU.*
  - *l'article 3.2, covering the requirements relative to proper use of the radio-frequency spectrum.*

To this end, the notified body n°0573:

**AEMC Lab**  
**19, rue François Blumet**  
**ZI de l'Argentière**  
**38330 SASSENAGE**  
**FRANCE**

Conducted testing of the above receiver unit for Electromagnetic Compatibility (3.1b) and for compliance with the spectrum (3.2), according to following standards:

- |  |                                    |
|--|------------------------------------|
| ☒ <i>EN 62061 :2005/ +A1 :2013+ A2 :2015</i> | ☒ <i>EN 61326-1 : 2013</i>         |
| ☒ <i>EN 61000-6-7 : 2015</i>                 | ☒ <i>EN 300220-2 V3.1.1</i>        |
| ☒ <i>EN 61000-6-2 : 2005</i>                 | ☒ <i>EN 62479 :2010</i>            |
| ☒ <i>EN 61000-6-2 : 2016</i>                 | ☒ <i>Draft EN 301 489-3 V2.1.0</i> |
| ☒ <i>EN 61326-3-1 : 2017</i>                 | ☒ <i>Draft EN 301 489-1 V2.2.0</i> |

included in the reports : nb.**R1908284R1-E**, and nb.**R1908284C1-E**.

- With the requirements of the European Directive of the Council of Europe dated June 8, 2011, relative to the limitation of use of certain dangerous substances in electrical and electronic equipment (RoHS), (2011/65/EU).
- With the requirements of the European Directive of the Council of Europe dated July 4, 2012, relative to electrical and electronic equipment waste (WEEE), (2012/19/EU).

**Signatory:** Responsible person authorized to compile the technical file (2006/42 Annex II § 2), and empowered to draw up the declaration on behalf of the manufacturer (2006/42 Annex II § 10). This declaration of conformity is issued under the sole responsibility of the manufacturer:

**Name:** Pascal De Boissieu; **Function:** Technical Manager.

**Place and Date:** JAY Electronique ZAC Bâtie Street Champrond 38334 St Ismier France on 06/04/2020.

**Signature:** signed on original

## 20.4 Receiver UDR

Translated from French

**EN**

**DECLARATION OF CONFORMITY**

The manufacturer :

**JAY Electronique**  
**ZAC la Bûche, rue Champrouf**  
**38334 ST ISMIER Cedex**  
**FRANCE**

Declares that the receiver described in the user manual and mentioned here below:

**UDR**

Complies:

■ With the requirements specified for the machines defined in Appendix I of the Directive 2006/42/EC concerning alignment of the legislation of the member states relative to machinery on the basis of compliance with the following standards :

- EN ISO 13849-1 :2015 Requirements for performance level PL d (Category 3)
- EN 62061 :2005 + AC :2010 + A1 :2013 + A2 :2015 Requirements for SIL 2
- IEC 61508 Parts 1 to 3 :2010 Requirements for SIL 2
- EN ISO 13850 (2015) Clause 4.14 Stop category 0
- EN 60204-1 :2006 + A1 :2009 + AC :2010, Paragraph 9.2.2 category 0.
- EN 60947-5-1 :2004 + AC :2005 + A1 :2009
- EN 13337 + A2 :2008 Paragraphs 5.1 ; 5.2.3 and Annex C.

This equipment can be used in applications up to Category 3 (PL d) according to EN ISO 13849-1 and SIL 2 according to EN 62061 and EN 61508. For its safety outputs, when combined with the appropriate transmitter.

■ With the requirements of the European Directive 2014/53/EU of the Council of Europe of April 16th 2014, concerning the alignment of the legislations of the member states, relative to radio equipment and telecommunication terminals with special reference to:

- article 3.1 a, concerning the protection requirements of the health and safety of people and domestic animals, and the protection of property with Directive 2014/53/EU according to the following standards : EN 60950-1 :2006 + A11 :2009 + A1 :2010 + A12:2011 + AC :2011 + A2 : 2013 or EN 62479 :2010
- Article 3.1 b, covering the requirements relative to protection as concerns electromagnetic compatibility, with Directive 2014/53/EU.
- Article 3.2, covering the requirements relative to proper use of the radio-frequency spectrum.

To this end, the notified body n°0573:

**AEMC Lab**  
**19, rue François Blomet**  
**ZI de l'Argentan**  
**38330 SASSINAGE**  
**FRANCE**

Conducted testing of the above receiver unit for Electromagnetic Compatibility (3.1b) and for compliance with the spectrum (3.2), according to following standards:

■ EN 62061 :2005/ +A1 :2013+ A2 :2015	■ EN 61326-1 : 2013
■ EN 61000-6-7 : 2015	■ EN 62479 :2010
■ EN 61000-6-2 : 2005	■ EN 300220-2 V3.1.1
■ EN 61000-6-2 : 2016	■ Draft EN 301 489-3 V2.1.0
■ EN 61326-3-1 : 2017	■ Draft EN 301 489-1 V2.2.0

included in the reports : nb. **R1906199R1-E**, and nb. **R1906199C1-E-A1**.

- With the requirements of the European Directive of the Council of Europe dated June 8, 2011, relative to the limitation of use of certain dangerous substances in electrical and electronic equipment (RoHS), (2011/65/EU).
- With the requirements of the European Directive of the Council of Europe dated July 4, 2012, relative to electrical and electronic equipment waste (WEEE), (2012/19/EU).

**Signatory:** Responsible person authorized to compile the technical file (2006/42 Annex II § 2), and empowered to draw up the declaration on behalf of the manufacturer (2006/42 Annex II § 10).  
This declaration of conformity is issued under the sole responsibility of the manufacturer:  
**Name:** Pascal De Boissieu, **Function:** Technical Manager.  
**Place and Date:** JAY Electronique ZAC Bûche Street Champrouf 38334 St Ismier France on 11/27/2019.

**Signature:** signed on original

31942C\_308 31942D UDR Declaration de conformité FR EN DE IT ES

## 21.1 Transmitter UDEE

TCB

GRANT OF EQUIPMENT  
AUTHORIZATION

TCB

Certification  
Issued Under the Authority of the  
Federal Communications Commission  
By:

Nemko Canada Inc.  
303 River Road  
Ottawa, Ontario, K1V 1H2  
Canada

Date of Grant: 10/30/2009  
Application Dated: 10/29/2009

Jay Electronique  
ZAC la bâtie, rue champrond  
Saint Ismier, F38334  
France

Attention: Normand Olivier , Chairman

NOT TRANSFERABLE

EQUIPMENT AUTHORIZATION is hereby issued to the named GRANTEE, and  
is VALID ONLY for the equipment identified hereon for use under the  
Commission's Rules and Regulations listed below.

FCC IDENTIFIER: **OQMUD**  
Name of Grantee: **Jay Electronique**  
Equipment Class: Part 15 Low Power Communication Device  
Transmitter  
Notes: Industrial Enhanced Safety Radio Controls  
transmitter

<u>Grant Notes</u>	<u>FCC Rule Parts</u>	<u>Frequency Range (MHZ)</u>	<u>Output Watts</u>	<u>Frequency Tolerance</u>	<u>Emission Designator</u>
	15C	911.8 - 918.2			



## 21.2 Receiver UDRE

TCB

GRANT OF EQUIPMENT  
AUTHORIZATION

TCB

Certification  
Issued Under the Authority of the  
Federal Communications Commission  
By:

Nemko Canada Inc.  
303 River Road  
Ottawa, Ontario, K1V 1H2  
Canada

Date of Grant: 10/30/2009  
Application Dated: 10/29/2009

Jay Electronique  
ZAC la bâtie, rue champrond  
Saint Ismier, F38334  
France

Attention: Normand Olivier , Chairman

NOT TRANSFERABLE

EQUIPMENT AUTHORIZATION is hereby issued to the named GRANTEE, and  
is VALID ONLY for the equipment identified hereon for use under the  
Commission's Rules and Regulations listed below.

FCC IDENTIFIER: **OQMUDR**  
Name of Grantee: **Jay Electronique**  
Equipment Class: Communications Receiver used w/Pt 15  
Transmitter  
Notes: Industrial Enhanced Safety Radio Controls  
receiver

<u>Grant Notes</u>	<u>FCC Rule Parts</u>	<u>Frequency Range (MHZ)</u>	<u>Output Watts</u>	<u>Frequency Tolerance</u>	<u>Emission Designator</u>
	15B	911.8 - 918.2			





ZAC la Bâtie, rue Champrond  
F38330 SAINT ISMIER

Tel : +33 (0)4 76 41 44 00

[www.jay-electronique.com](http://www.jay-electronique.com)